



Product End-of-Life Disassembly Instructions

Product Category: Personal Computers

Marketing Name / Model

[List multiple models if applicable.]

HP Pro 3000 Small Form Factor Business PC

Purpose: The document is intended for use by end-of-life recyclers or treatment facilities. It provides the basic instructions for the disassembly of HP products to remove components and materials requiring selective treatment, as defined by EU directive 2002/96/EC, Waste Electrical and Electronic Equipment (WEEE).

1.0 Items Requiring Selective Treatment

1.1 Items listed below are classified as requiring selective treatment.

1.2 Enter the quantity of items contained within the product which require selective treatment in the right column, as applicable.

Item Description	Notes	Quantity of items included in product
Printed Circuit Boards (PCB) or Printed Circuit Assemblies (PCA)	With a surface greater than 10 sq cm	3(1 sys board, 2 P/S board)
Batteries	All types including standard alkaline and lithium coin or button style batteries	1
Mercury-containing components	For example, mercury in lamps, display backlights, scanner lamps, switches, batteries	0
Liquid Crystal Displays (LCD) with a surface greater than 100 sq cm	Includes background illuminated displays with gas discharge lamps	0
Cathode Ray Tubes (CRT)		0
Capacitors / condensers (Containing PCB/PCT)		0
Electrolytic Capacitors / Condensers measuring greater than 2.5 cm in diameter or height		5 (P/S board Capacitors,)
External electrical cables and cords		0
Gas Discharge Lamps		0
Plastics containing Brominated Flame Retardants weighing > 25 grams (not including PCBs or PCAs)		0

already listed as a separate item above)		
Components and parts containing toner and ink, including liquids, semi-liquids (gel/paste) and toner	Include the cartridges, print heads, tubes, vent chambers, and service stations.	0
Components and waste containing asbestos		0
Components, parts and materials containing refractory ceramic fibers		0
Components, parts and materials containing radioactive substances		0

1.3 Markings for plastic parts greater than 25 grams

Plastic Part Name	Plastic Part Description	Weight (grams)	ISO 11469:2000 Plastic Part Mark	Optional: Photo
Santa Anna SFF Main Bezel	Main front bezel piece	72	>ABS<	
Santa Anna SFF Bezel Frame	Front bezel frame	54	>ABS<	
SFF CPU Cooler Fan Duct	Duct for CPU fan	30	>PC+ABS FR(40)<	

2.0 Tools Required

List the type and size of the tools that would typically be used to disassemble the product to a point where components and materials requiring selective treatment can be removed.

Tool Description	Tool Size (if applicable)
Description #1 Torx screwdriver	T15
Description #2 Phillips screwdriver	175mm
Description #3 Diagonal cutters (dikes)	165mm
Description #4	
Description #5	

3.0 Product Disassembly Process

3.1 List the basic steps that should typically be followed to remove components and materials requiring selective treatment:

1. SYSTEM BOARD:

(1). Remove the access panel: (a)Remove the two screws that secure the access panel to the computer chassis. (see Figure 1 below) (b)Pull the Access Panel to rear side and take off the Access Panel. (see Figure 2 below)

(2). Remove the front bezel: (see Figure 3 below) (a)Release the 3 front bezel snaps on the top side of the bezel. (b) Rotate the front bezel and take off.

(3). Disconnect the power, and data cables from the back of all installed drives.

(4). Disconnect all cables from the system board.

(5). Remove the heatsink from the system board: (see Figure 4 below) (a)Disconnect the heatsink control cable from the system board. (b)Loosen the four captive screws that secure the heatsink to the system board. (c)Lift the heatsink from atop the processor and set it on its side to keep from contaminating the work area with thermal grease.

(6). Remove the system board: (see Figure 5 below) (a)Remove the 8 screws that secure the system board to the chassis. (b) Lift the system board and depart form stand-off. (c) Slide the system board towards the front of the chassis then remove it.

NOTE: The system board in the computer may look slightly different from the one shown here.

2. POWER SUPPLY PRINTED CIRCUIT ASSEMBLY :

(01. Remove the power supply: (see Figure 6 below) (a) Remove all cables connected to all devices in the chassis. (b) Using a phillips screwdriver, remove the four screws that secure the power supply to the chassis. (c)Slide the power supply toward the front of the computer, and then lift it out of the chassis.

(2). Remove the cover from the power supply: (a) Using a phillips screwdriver, remove the 4 screws that secure the cover to the PSU chassis. (see Figures 7 & 8 below) (b)Using diagonal cutters (dikes), cut the plastic cable clamp that secures the cables to the PSU chassis. (see Figure 9 below) (c) Disconnect two control cables from the PSU PCA. (1 to FPC, 1 to PSU fan) (see Figure 10 below) (d)Lift the cover off the power supply.

(3). Remove the power supply PCA: (a) Remove the 3 screws that secure the power supply PCA to the PSU chassis. (see Figure 11 below) (b)Using diagonal cutters (dikes), cut all cables connected to the PCA. (2 to switch, 2 to PC inlet) (see Figure 12 below) (c) Remove the power supply PCA from the power supply chassis.

(4). Remove the Electrolytic Capacitors: (a) Using Soldering Iron, heat the solder of Electrolytic Capacitors. (see Figure 13 & 14 below) b) Remove the Electrolytic Capacitors. (see Figure 15 below)

3. BATTERY: Locate the battery and battery holder on the system board. Depending on the type of battery holder on the system board, follow the instructions below to remove the battery:

(1). TYPE 1 BATTERY HOLDER (see Figure 16 below) Lift the battery out of the holder.

(2). TYPE 2 BATTERY HOLDER (see Figure 17 below) To release the battery from its holder, squeeze the metal clamp that extends above one edge of the battery. When the battery pops up, lift it out.

(3). TYPE 3 BATTERY HOLDER (see Figure 18 below) Pull back on the clip that holds the battery in place, and then remove the battery.

4.
5.
6.
7.
8.

3.2 Optional Graphic. If the disassembly process is complex, insert a graphic illustration below to identify the items contained in the product that require selective treatment (with descriptions and arrows identifying locations).

Figure 1: Remove the two screws



Figure 2: Remove the access panel

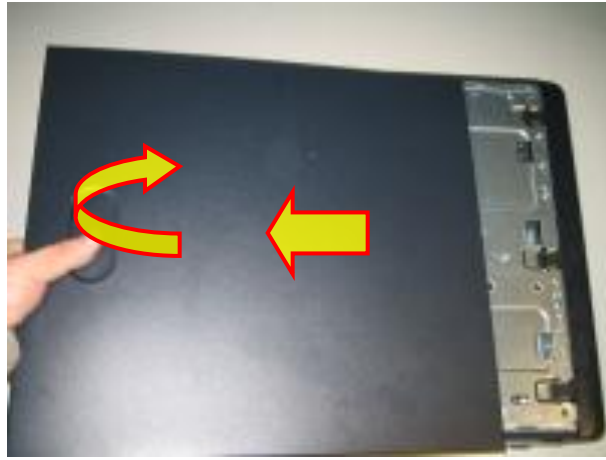

Figure 3: Remove the front bezel

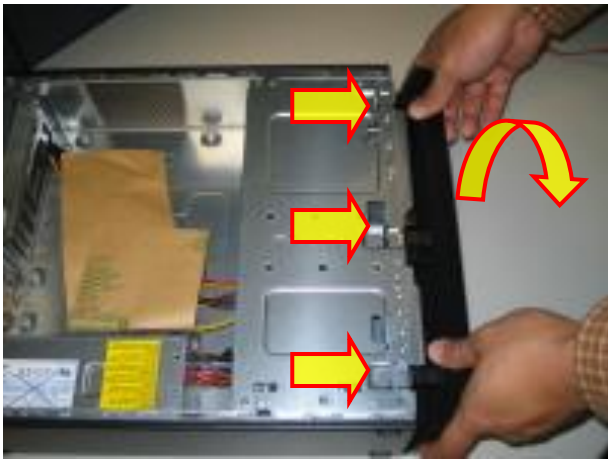

Figure 4: Remove the heat sink

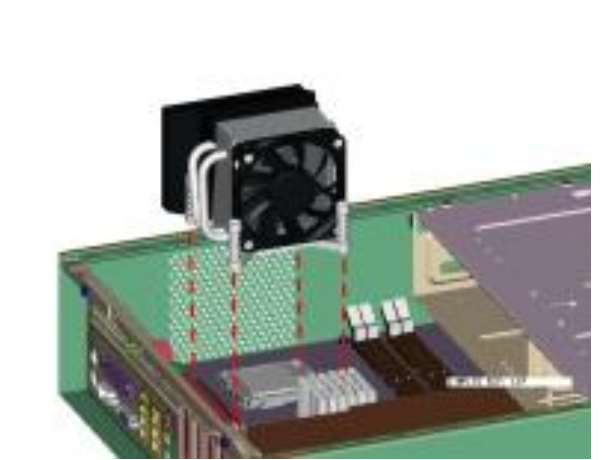

Figure 5: Remove the system board

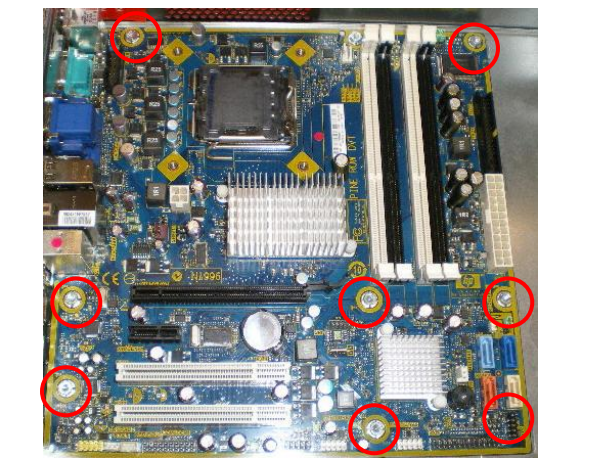

Figure 6: Power supply screw locations on the chassis

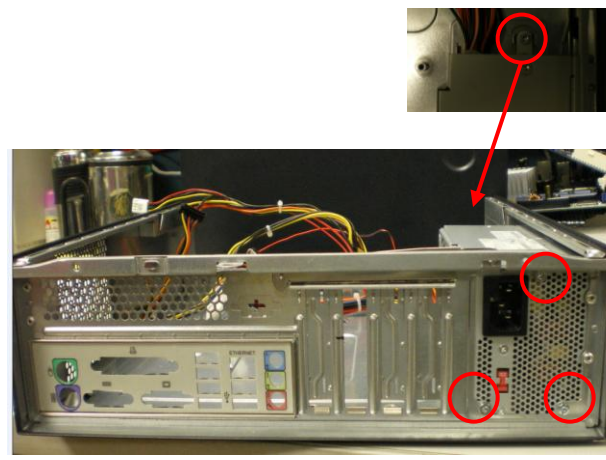

Figure 7: Power supply cover screw locations on the top side



Figure 8: Power supply cover screw locations on the bottom side



Figure 9: Cut the plastic cable clamp



Figure 10: Disconnect two control cables



Figure 11: Power supply PCA screw location



Figure 12: Cut all cables connected to the board



Figure 13 : Electrolytic Capacitors location



Figure 14 : Heat the solder of Electrolytic Capacitors



Figure 15 : Remove the Electrolytic Capacitors

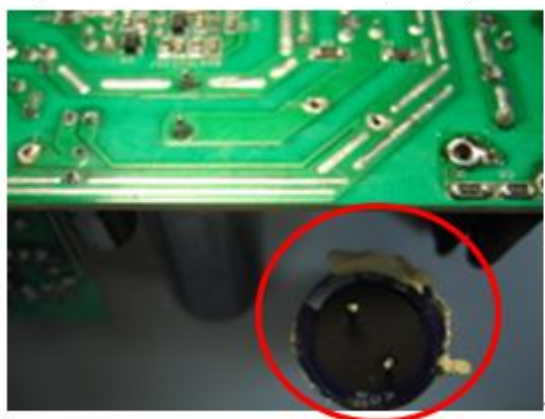

Figure 16 : Type 1 battery holder

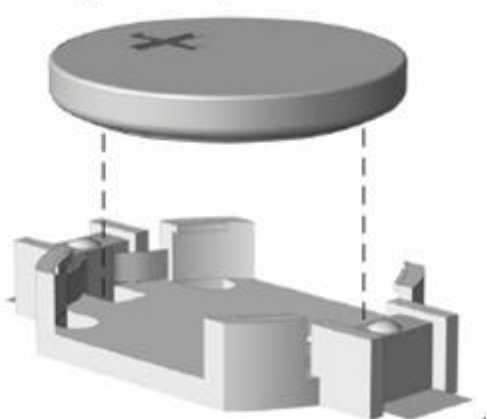

Figure 17 : Type 2 battery holder



Figure 18 : Type 3 battery holder

