

**hp psc 2170 series
all-in-one**



i n v e n t



reference guide

© Copyright Hewlett-Packard Company 2003

All rights are reserved. No part of the document may be photocopied, reproduced, or translated to another language without the prior written consent of Hewlett-Packard Company.

This product incorporates Adobe's PDF technology, which contains an implementation of LZW licensed under U.S. Patent 4,558,302.



Adobe and the Acrobat logo are either registered trademarks or trademarks of Adobe Systems Incorporated in the United States and/or other countries.

Portions Copyright © 1989-2003 Palomar Software Inc. The HP PSC 2170 Series includes printer driver technology licensed from Palomar Software, Inc. www.palomar.com
Copyright © 1999-2003 Apple Computer, Inc.

Apple, the Apple logo, Mac, Mac logo, Macintosh, and Mac OS are trademarks of Apple Computer, Inc., registered in the U.S. and other countries.

Publication number: Q3066-90152

First edition: January 2003

Printed in the U.S.A., Mexico, Germany, or Korea.

Windows[®], Windows NT[®], Windows ME[®], Windows XP[®], and Windows 2000[®] are U.S.-registered trademarks of Microsoft Corporation.

Intel[®] and Pentium[®] are registered trademarks of Intel Corporation.

notice

The information contained in this document is subject to change without notice and should not be construed as a commitment by the Hewlett-Packard Company.

Hewlett-Packard assumes no responsibility for any errors that may appear in this document, nor does it make expressed or implied warranty of any kind with regard to this material, including, but not limited to, the implied warranties of merchantability and fitness for a particular purpose.

The Hewlett-Packard Company shall not be liable for incidental or consequential damages in connection with, or arising out of the furnishing, performance, or use of this document and the program material which it describes.

Note: Regulatory information can be found in the "Technical information" section of this guide.



It is not lawful in many places to make copies of the following items. When in doubt, check with a legal representative first.

- Governmental paper or documents:
 - Passports
 - Immigration papers
 - Selective service papers
 - Identification badges, cards, or insignias
- Governmental stamps:
 - Postage stamps
 - Food stamps
- Checks or drafts drawn on Governmental agencies
- Paper currency, traveler's checks, or money orders
- Certificates of deposit
- Copyrighted works

safety information

Warning! To prevent fire or shock hazard, do not expose this product to rain or any type of moisture.

Always follow basic safety precautions when using this product to reduce risk of injury from fire or electric shock.

Warning! Potential shock hazard.

- 1 Read and understand all instructions in the setup poster.
- 2 Use only a grounded electrical outlet when connecting the unit to a power source. If you do not know whether the outlet is grounded, check with a qualified electrician.
- 3 Observe all warnings and instructions marked on the product.
- 4 Unplug this product from wall outlets before cleaning.
- 5 Do not install or use this product near water or when you are wet.
- 6 Install the product securely on a stable surface.
- 7 Install the product in a protected location where no one can step on or trip over the line cord, and where the line cord will not be damaged.
- 8 If the product does not operate normally, see the online Troubleshooting help.
- 9 No operator-serviceable parts inside. Refer servicing to qualified service personnel.
- 10 Use in a well-ventilated area.

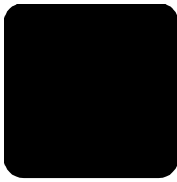

contents

1	get help	1
2	front panel overview	3
	tutorial	3
	use your hp psc with a computer	6
3	load originals and load paper	9
	load originals	9
	load paper	9
	load envelopes	11
	load 4 x 6 inch photo paper	12
	load postcards or hagaki cards	12
	tips for loading other types of paper in the paper tray	13
	set the paper type	14
	set the paper size	14
4	use a photo card	17
	what is a photo card?	17
	insert a photo card	18
	save files to the computer	18
	hp photo & imaging gallery	19
	print a proof sheet	19
	complete the proof sheet	19
	print photos by scanning a proof sheet	20
	print selected photos directly from a photo card	21
	how to print the best quality photos	22
	options menu for photo card and proof sheet commands	23
5	use the copy features	25
	make copies	25
	perform special copy jobs	28
	stop copying	31
	copy options	31
6	use the scan features	33
	scan an original	33
	stop scanning	34
	learn more	35

7	maintain your hp psc	37
	clean the glass	37
	clean the lid backing	37
	clean the exterior.	37
	work with print cartridges	38
	restore factory defaults	42
	set the power save time	42
	set scroll speed	43
	set the prompt delay time	43
	setup menu options	43
8	additional setup information.	45
	possible installation problems	45
	set the language and country/region.	47
	set the front-panel view angle	47
	connect your hp psc to your computer	48
	remove and reinstall your hp psc software.	48
9	technical information	51
	system requirements	51
	paper specifications.	52
	print specifications	53
	print margin specifications	53
	copy specifications	54
	photo card specifications	54
	scan specifications.	54
	physical specifications	55
	power specifications	55
	environmental specifications	55
	additional specifications.	55
	environmental product stewardship program	55
	regulatory notices	56
10	get hp psc 2170 series support.	61
	get support and other information from the internet	61
	hp customer support	61
	prepare your unit for shipment	63
	hp distribution center	64
11	warranty information.	65
	warranty service	65
	warranty upgrades	65
	returning your hp psc 2170 series for service	65
	hewlett-packard limited global warranty statement	65

index **69**



get help

This Reference Guide contains information on using your HP PSC and provides additional troubleshooting assistance for the installation process. The Reference Guide also contains information on how to order supplies and accessories, technical specifications, support, and warranty information.

The table below lists additional sources of information for your HP PSC.

help	description
Setup Poster	The Setup Poster provides instructions for setting up and configuring your HP PSC. Make sure you use the correct poster for your operating system (Windows or Macintosh).
HP Photo & Imaging Help	The HP Photo & Imaging Help provides detailed information on using the software for your HP PSC. For Windows users: Go to the HP Director , and click Help . For Macintosh users: Go to the HP Director , and click Help , then click hp photo and imaging help .
Troubleshooting help	For Windows users: In the HP Director , click Help . Open the Troubleshooting book in the HP Photo & Imaging Help, then follow the links to general troubleshooting as well as links to Troubleshooting help that is specific to your HP PSC. Troubleshooting is also available from the Help button that appears on some error messages. For Macintosh users: Open the Apple Help Viewer, click hp photo and imaging troubleshooting , then click hp psc 2170 series .
Internet help and technical support	If you have Internet access, you can get help from the HP website at: http://www.hp.com/support The website also provides answers to frequently-asked questions, troubleshooting tips, and software patches.
Readme file	After you install your software, you can access the Readme file from either the HP PSC 2170 Series CD-ROM or the HP PSC 2170 Series program folder. The Readme file contains late-breaking information that does not appear in the Reference Guide or the online help. To access the Readme file, do the following: For Windows: go to the Windows taskbar, click Start , point to Programs or All Programs (XP) , point to Hewlett-Packard , point to HP PSC 2170 Series , and then choose View the Readme File . For Macintosh: go to the HD:Applications:HP PSC Software folder.
Dialog-box help	For Windows: Clicking Help in a dialog box displays information about options and settings within the dialog box.

2

front panel overview

You can perform many functions using either the front panel or the HP PSC software.

Even if you do not connect your HP PSC to a computer, you can use the front panel to copy documents or photos, print a proof sheet for a photo card, and print photos from a photo card. You can change a wide variety of settings using the front-panel buttons and menu system.

tutorial

This brief tutorial teaches you how to use your HP PSC to make a copy, adjust copy settings, and print a report. This is not a comprehensive tutorial; its purpose is to familiarize you with the front panel and the different buttons. It should take about ten minutes to complete the tutorial, after which you can experiment on your own.

Note: We highly recommend that you take this tutorial before you start using your HP PSC for daily tasks.

Review the table of contents or the index to find out about the other front-panel tasks covered in this online help.

- **before you begin**
- **front panel features**
- **make a copy**
- **enhance your copy**
- **setup button**

before you begin

Do the following:

- Follow the instructions in the Setup Poster to set up your HP PSC. You should install the HP PSC software before connecting the HP PSC to the computer.
- Make sure paper is loaded in the paper tray. If you need more information, see **load paper** on page 9.
- Have available a color photograph or picture that is smaller than Letter or A4 size. You will use this image for tutorial activities.
- Obtain a two or three-page document. You will use it for tutorial activities.

front panel features

Review the illustrations below and identify the location of the buttons on the front panel.

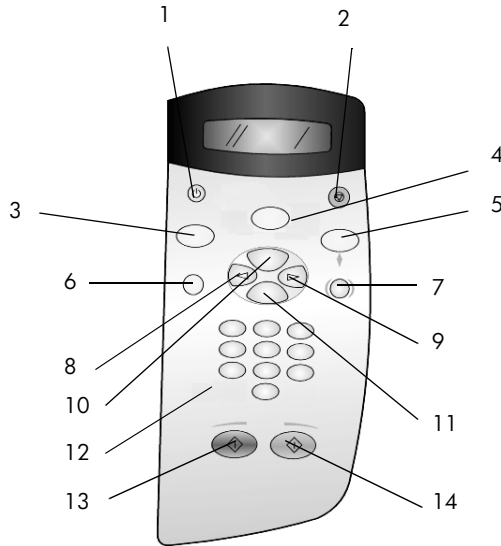

button	purpose
1	On: Turn the HP PSC on or off.
2	Cancel: stop a job, exit a menu, or exit settings.
3	Copy: select the copy function. When the button is lit, the copy function is selected. This button is lit by default.
4	Scan: select the scan function. When the button is lit, the scan function is selected.
5	Photo Card: select the Photo Card function. When the button is lit, the Photo Card function is selected. Use this button to print photos from a photo card or to save photos to your PC.
6	Setup: access the menu system for reports and maintenance.
7	Proof Sheet: print a proof sheet when a photo card has been inserted in a photo card slot. A proof sheet shows thumbnail views of all the photos on the photo card. You can select photos on the proof sheet, then print those photos by scanning the proof sheet.
8	Left Arrow: scroll through settings, or to delete one character at a time from a text entry.
9	Right Arrow: scroll through settings.
10	Options: display copy, scan, or photo card print options. Press Copy , Scan , or Photo Card , then press Options to modify options for the selected function. You can also display options for the selected function by pressing Copy , Scan , or Photo Card repeatedly.
11	Enter: select or save the displayed setting.
12	Keypad: enter values.
13	Start Black: start a black and white copy, scan, or photo card print job.
14	Start Color: use to start a color copy, scan, or photo card print job.

Review the rest of this HP PSC 2170 Series help to find out how to make other changes and use other features.

make a copy

Follow the instructions below to make a copy of your color photo or picture.

- 1 Open the lid of your HP PSC and place your picture face down in the bottom-right corner of the scanner glass with the sides of the picture touching the right and bottom edges.

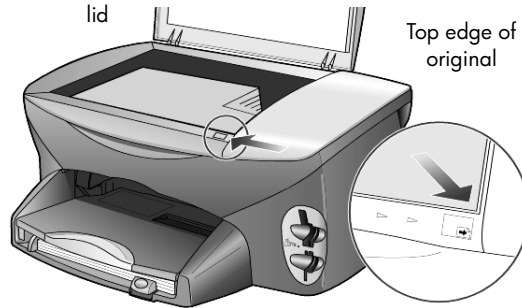

- 2 Press **Start Color**.

If you had wanted to save the picture to the computer, you would have pressed **Scan**, then **Start Color**. For this tutorial, you will continue making a copy.

The default is a single copy. Pressing the **Start Color** button on the HP PSC automatically prints one color copy of the picture on the glass. If you had pressed the **Start Black** button, the HP PSC would have made a single black-and-white copy of your color picture.

enhance your copy

- 1 Without moving your photo or picture from the glass, press the **Copy** button, or the **Options** button, then press **▶** to increase the number of copies to 2.
- 2 Press **Start Black** on the front panel.
The HP PSC makes two black-and-white copies of your picture.
Notice that you did not have to do anything else but select the number of copies and press a start key. Now you will change an additional setting before making more copies.
- 3 Press the **Copy** button, or the **Options** button, then press **▶** to increase the number of copies to 3.
- 4 Press **Options** until **Reduce/Enlarge** appears.
- 5 Press **▶** until **Custom 100%** appears in the front-panel display, then press **Enter**.
Use this option to reduce or enlarge your picture.
- 6 Press **◀** until **75%** appears, then press **Enter**.
- 7 Press **Start Color** on the front panel.
The HP PSC prints three color copies of your picture, reduced to 75% of its original size.

If you do not do anything else with your HP PSC, the settings that you adjusted will return to their default settings within two minutes. The number of copies returns to one and the copy percentage returns to 100%.

- 8 If you do not want to wait for two minutes, press **Cancel**.
Next you will use the **Fit to Page** option to enlarge your photograph.
- 9 Press **Options** until **Reduce/Enlarge** appears.
- 10 Press  until **Fit to Page** appears.
- 11 Press **Start Black** or **Start Color**.
A copy of your picture is printed, which fills the whole page.

setup button

The **Setup** button lets you enter the menu system that you use to change scan setup, as well as perform maintenance and print reports.

- 1 Press **Setup**.
The first submenu appears.
- 2 Press **Setup** repeatedly to view all the submenus.
The submenus are as follows:
 - 1:Print Report
 - 2:Maintenance
- 3 Press **Setup** until **Print Report** appears, then press **Enter**.
- 4 Press  until **Self-Test Report** appears, then press **Enter**.
A self-test report is printed.
This concludes the brief tutorial.
Review the rest of this HP PSC 2170 Series help to find out how to make other changes and use other features.

use your hp psc with a computer

If you installed the HP PSC software on your computer according to the Setup Poster, you can access all the features of the HP PSC using the HP Director.

review the hp photo & imaging director

The HP Director is available through the desktop shortcut.

for windows users

- 1 Do one of the following:
 - Double-click the **hp director** icon on the desktop.
 - In the Windows taskbar, click **Start**, point to **Programs** or **All Programs** (XP), point to **Hewlett-Packard**, point to **hp psc 2170**, then choose **hp photo & imaging director**.
- 2 In the **Select Device** box, click to see a list of installed HP devices.
- 3 Select **hp psc 2170**.
The Director displays only the buttons that are appropriate for the selected device.

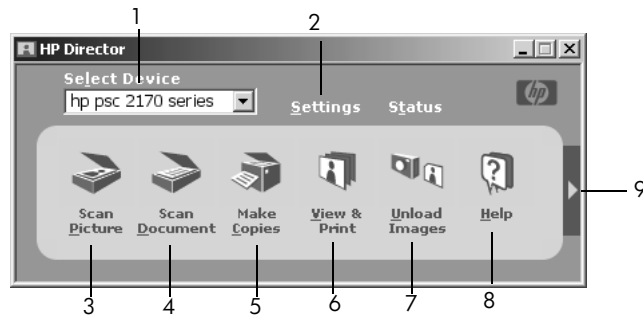

the hp photo & imaging director

feature	purpose
1	Select Device: Use this feature to select the product you want to use from the list of installed HP products.
2	Settings: Use this feature to view or change various settings for your HP device, such as print, scan, copy, or image unload.
3	Scan Picture: Scans an image and displays it in the HP Photo & Imaging Gallery.
4	Scan Document: Scans text and displays it in the selected destination text editing software program.
5	Make Copies: Displays the Copy dialog box where you can select the copy quality, the number of copies, the color, the size, and can start a copy.
6	View & Print: Displays the HP Photo & Imaging Gallery, where you can view and edit images, use HP Creative Printing, make and print a photo album, e-mail an image, unload an image to the Web, or copy an image to another application.
7	Unload Images: Saves images from a photo card to your PC.
8	Help: Provides access to HP Photo & Imaging Help, which provides software help, a product tour, and troubleshooting information.
9	Click this arrow to access tool tips, which explain each of the Director options.

for macintosh users

- ▶ Do one for the following:
 - For OS 9, double-click the **HP Director** icon on the desktop.
 - For OS X, double-click the **HP Director** icon on the dock.

The following figure shows some of the features available through the HP Director for Macintosh. Consult the legend for a brief explanation of a specific feature.

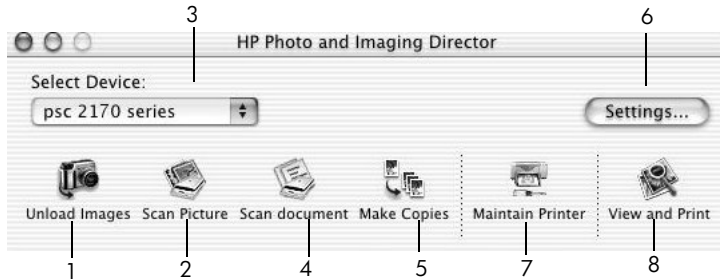

the hp photo and imaging director for macintosh, in OS9 and OSX

feature	purpose
1	Unload Images: Unloads the images from a photo card.
2	Scan Picture: Scans an image and displays it in the HP Photo and Imaging Gallery.
3	Use this pull-down list to select the product you want to use from the list of installed HP products.
4	Scan Document: Scans text and displays it in the selected destination text editing software program.
5	Make Copies: Copies in black and white or color.
6	Settings: Accesses the device settings.
7	Maintain Printer: Opens the printer utility.
8	View and Print: Displays the HP Photo and Imaging Gallery, where you can view and edit images.

3

load originals and load paper

You can make copies from originals loaded on the glass. You can also print and copy onto a variety of paper types, weights, sizes, and transparency films. It is important, however, that you choose the appropriate paper and make sure that it is loaded correctly and not damaged.

load originals

You can copy or scan any original by placing it on the glass.

Note: Many of the **Reduce/Enlarge** options, such as **Fit to Page** or **Poster**, will not work correctly if the glass and lid backing are not clean. For more information, see **clean the glass** on page 37 and **clean the lid backing** on page 37.

- 1 Lift the lid and place the original face down on the glass in the front-right corner with the sides of the originals touching the right and front edges. It is important to use the front-right corner when using the copy feature.

Tip: If you are copying from a transparency (that is, your original is printed on transparency film), place a blank piece of paper on top of the transparency.

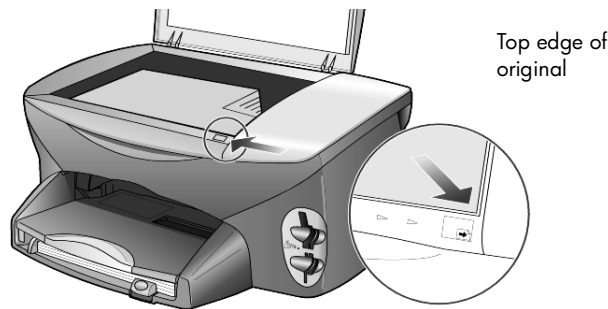

- 2 Close the lid.

load paper

Following is the basic procedure for loading paper. There are specific considerations for loading certain types of paper, transparency film, postcards, and envelopes. After you review this procedure, see **tips for loading other types of paper in the paper tray** on page 13, **load 4 x 6 inch photo paper** on page 12, **load envelopes** on page 11, and **load postcards or hagaki cards** on page 12.

For information on choosing paper for printing and copying, see **recommended papers** and **papers to avoid** in the **HP Photo & Imaging Help**.

For best results, adjust the paper settings each time you change paper types or paper sizes. For more information, see **set the paper type** on page 14.

to load the paper tray

- 1 Remove the output tray, and slide the paper-width and paper-length guides to their outermost positions.

Note: Diagrams stamped on the output tray provide tips for installing print cartridges. The location of the Support Web site for HP PSC products, www.hp.com/support, is also provided.

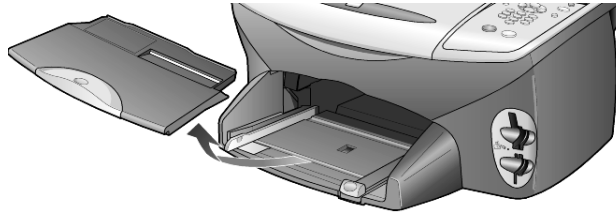

- 2 Tap the stack on a flat surface to align the edges of the paper, and then check the paper for the following:
 - Make sure it is free of rips, dust, wrinkles, and curled or bent edges.
 - Make sure all the paper in the stack is the same size and type, unless you are working with photo paper.

- 3 Insert paper into the paper tray print-side down until it stops. If you are using letterhead, insert the top of the page first. Be careful not to use too much or too little paper. Check that the stack of paper contains several sheets but is no higher than the top of the paper-length guide.

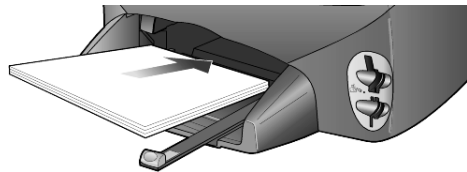

- 4 Slide the paper-width and paper-length guides in until they stop at the edges of the paper. Make sure that the paper stack lies flat in the paper tray and fits under the tab of the paper-length guide.

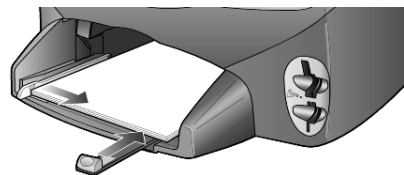

- 5 Replace the output tray.

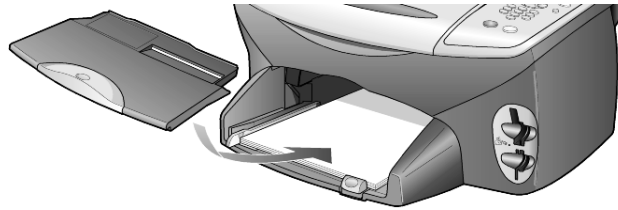

- 6 To prevent printed paper from falling off the tray, fully extend the output-tray extender.

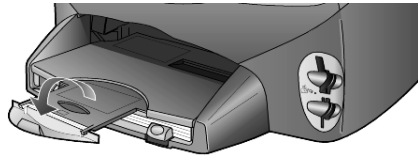

load envelopes

Use the print feature of your software to print to envelopes with your HP PSC. Your HP PSC provides two methods for working with envelopes. Do *not* use shiny or embossed envelopes, or envelopes that have clasps or windows.

- If you are printing one envelope, slide the envelope into the envelope slot, which is located on the right side toward the back of the output tray. Insert the envelope with the flap up and on the left, as shown in the illustration. Slide the envelope until it stops.

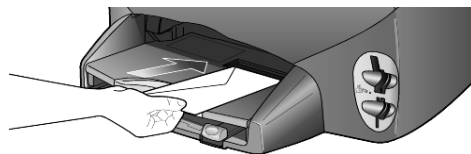

- If you are printing multiple envelopes, remove all paper from the paper tray, and then slide a stack of envelopes into the tray, with the envelope flaps up and to the left (print-side down), until they stop.

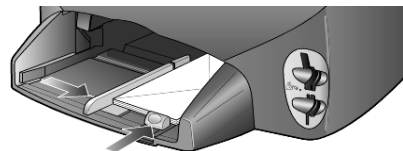

Adjust the paper-width guide against the envelopes (be careful not to bend the envelopes). Make sure the envelopes fit within the tray (do not overload it).

Consult the help files in your word processing software for details on how to format text for printing on envelopes.

load 4 x 6 inch photo paper

Following is the procedure for loading 4-by-6 inch (10-by-15 cm) photo paper into your HP PSC.

- 1 Remove all paper from the paper tray, and then slide a stack of photo paper into the tray until it stops.

Make sure the print side (glossy) faces down.

If the photo paper you are using has perforated tabs, load the photo paper so that the tabs are closest to you. Refer to the icons stamped on the input that indicate how tabbed media should be loaded.

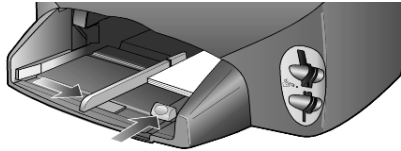

- 2 Adjust the paper-width guide against the stack of photo paper, and then slide the paper-length guide in until it stops.

Make sure the photo paper fits within the tray (do not overload it).

Note: Make sure you set the paper type and paper size before printing. See **set the paper type** on page 14 and **set the paper size** on page 14.

load postcards or hagaki cards

Following is the procedure for loading postcards or hagaki cards.

- 1 Remove all paper from the paper tray, and then slide a stack of cards into the tray until they stop.

Make sure the print side faces down.

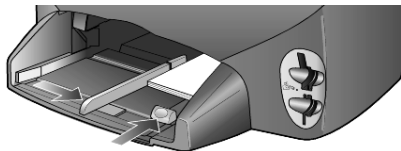

- 2 Adjust the paper-width guide against the cards, and then slide the paper-length guide in until it stops.

Make sure the cards fit within the tray (do not overload it).

tips for loading other types of paper in the paper tray

The following table provides guidelines for loading certain types of paper and transparency film. For best results, adjust the paper settings each time you change paper types and paper sizes. For more information, see **set the paper type** on page 14.

paper	tips
HP papers	<ul style="list-style-type: none"> • HP Premium Inkjet Paper: Locate the gray arrow on the nonprinting side of the paper, and then insert paper with the arrow side facing up. • HP Premium or Premium Plus Photo Paper: Load the glossy (print) side down. Always load at least five sheets of regular paper in the paper tray first, and then place the photo paper on top of the regular paper. • HP Premium Inkjet Transparency Film: Insert the film so that the white transparency strip (with arrows and the HP logo) is on top and is going into the tray first. • HP Inkjet T-shirt Transfer Iron-On: Flatten the transfer sheet completely before using it; do not load curled sheets. (To prevent curling, keep transfer sheets sealed in the original package until you are ready to use them.) Manually feed one sheet at a time, with the unprinted side facing down (the blue stripe faces up). • HP Matte Greeting Cards, HP Glossy Greeting Cards, or HP Felt-Textured Greeting Cards: Insert a small stack of HP greeting-card paper, with the print-side down, into the paper tray until it stops.
Labels (works only with printing)	<ul style="list-style-type: none"> • Always use letter-size or A4-size label sheets designed for use with HP inkjet products (like Avery Inkjet Labels), and make sure that the labels are not over two years old. • Fan the stack of labels to make sure none of the pages are sticking together. • Place a stack of label sheets on top of standard paper in the paper tray, print-side down. Do <i>not</i> insert labels one sheet at a time.
Postcards or hagaki cards (only works with printing)	<p>Insert a stack of postcards or hagaki cards with the print-side down into the paper tray until it stops. Line the postcards up on the right side of the paper tray, slide the width guide up against the left side of the cards, and then slide the paper-length guide in until it stops.</p>

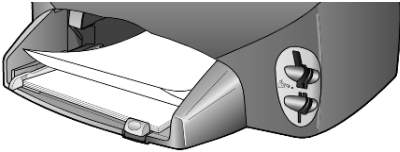
paper	tips
Continuous (banner) paper (works only with printing)	<p>Continuous banner paper is also known as computer or z-fold paper.</p> <ul style="list-style-type: none"> • Before loading banner paper, remove all other paper from the paper tray, then remove the output tray. • If you use non-HP banner paper, use 20-lb. paper and fan the paper before loading it. • Verify that the stack of banner paper contains at least five pages in the stack. • Carefully tear off the perforated edge strips from both sides of the paper stack, if any, and unfold and refold the paper to make sure the pages do not stick together. • Put the paper in the paper tray so that the unattached edge is at the top of the stack. Insert the first edge into the paper tray until it stops, as shown in the illustration below.  <ul style="list-style-type: none"> • Replace the output tray.

set the paper type

The default paper type is Automatic. The HP PSC will, in most cases, detect the paper type and automatically adjust the settings. If you want to use a different type of paper, such as photo paper, transparency film, Iron-On T-shirt transfers, or brochures, simply load that paper in the paper tray. You can then change the paper type settings to ensure the best print quality.

HP recommends paper type settings according to the type of paper you're using.

This setting refers to copy or photo card options only. If you want to set the paper type for printing from a computer, set the properties in the Print dialog box of the software.

- 1 Press **Copy** or **Photo Card**, if not already lit.
- 2 Press **Options** until **Paper Type** appears.
- 3 Press  until the appropriate paper type appears.
- 4 Press **Enter** to choose the displayed paper type.

set the paper size

The HP PSC can use Letter or A4 paper. If you are printing photos from a photo card, you can also use 4-by-6 inch (10-by-15 cm) photo paper. Use the following procedure to set the paper size for copy or photo card options.

- 1 Press **Copy** or **Photo Card**, if not already lit.
- 2 Press **Options** until **Paper Size** appears.
- 3 Press  until the appropriate paper size appears.
- 4 Press **Enter** to choose the displayed paper size.

To avoid jams, remove papers from the output tray frequently. The output tray capacity is affected by the type of paper and the amount of ink you are using. For more information about output-tray capacity, see **technical information** on page 51.

4

use a photo card

what is a photo card?

If your digital camera uses a photo card to store photos, you can insert the photo card in your HP PSC to print or save your photos.

You can print a Proof Sheet, which may be several pages long and shows thumbnail views of photos stored on the photo card, and print photos from the photo card, even if your HP PSC is not connected to a computer.

Your HP PSC can read SmartMedia, CompactFlash, Memory Stick, and SecureDigital photo cards. Each of these cards can have up to 128 megabytes of memory.

Your HP PSC features four different slots for photo card input, shown in the illustration below with the photo card that corresponds to each slot.

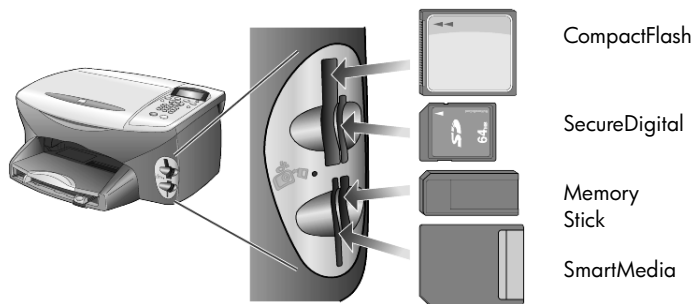

The IBM Microdrive photo card uses the same slot as the Compact Flash photo card, as shown in the following illustration.

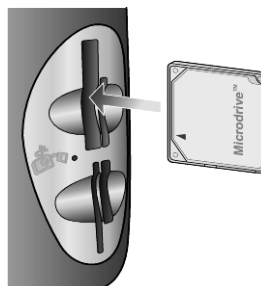

Note: You can only use one photo card in your HP PSC at a time.

Note: By default, Windows XP will format a CompactFlash photo card of 64MB or more with FAT32 format. Digital cameras and other devices use the FAT (FAT16) format and cannot operate with a FAT32 formatted card. Either format your CompactFlash card in your camera or select FAT format to format your CompactFlash card in a Windows XP PC.

insert a photo card

After you take photos with your digital camera, you can print them immediately or save them directly to your computer.

- 1 Insert the photo card into the appropriate slot on your printer.
When the photo card is inserted correctly, both the **Photo Card** button on the front panel and the LED next to the slot blink.
- 2 **Reading camera photo card...** appears on the front panel display. The light next to the card slot blinks green when the card is being accessed.
When the HP PSC is finished reading the card, the Photo Card button stops blinking and stays On and the light next to the card slot stops blinking.
- 3 Another message appears showing the number of files found on the photo card, followed by a prompt to save or print the photos.
 - 1 **Save to PC**
 - 2 **Print Photos**

Note: You may safely remove the card only when the LED next to the slot is off.

cards inserted incorrectly

If you insert a photo card backwards, the light next to the card slot blinks amber and the front panel may display an error message such as **Photo card is in backwards** or **Card is not fully inserted**.

save files to the computer

You can save directly from a photo card to your computer. When you save photos to your computer, you can view them in the HP Photo & Imaging Gallery, edit them, create photo collages, and album pages — the possibilities are endless.

When you are connected to a computer, you should save all the photos to your computer. This allows you to reuse your photo card.

- 1 Make sure that the photo card is inserted into the appropriate slot on your HP PSC.
- 2 Press **1** when **Save to PC** appears on the front panel display.
This saves all the photos from the photo card to your computer using the HP PSC software.

For Windows: by default, files are saved in month and year folders depending on when the photos were taken. The folders are created under the C:\MyDocuments\MyPictures folder. You can change the default location or the folders in which the files are saved.

For Macintosh: files are saved to the computer in the default location HardDrive/Documents/HP All-in-One Data/Photos directory.

hp photo & imaging gallery

You can use the HP Photo & Imaging Gallery for viewing and editing image files. You can print images, send images by e-mail or fax to family and friends, upload images to a website, or use images in fun and creative printing projects with the HP Photo & Imaging Gallery.

When you save photo card files to your computer, the HP Photo & Imaging Gallery opens automatically and displays thumbnails (small versions) of your images.

For Windows: if you want to open the HP Photo & Imaging Gallery at a later time, open the **Director** and click the **View & Print** icon, which is located in the middle of the Director window.

For Macintosh: if you want to open the HP Photo and Imaging Gallery at a later time, open the **Director** and click **View and Print Images**.

print a proof sheet

A Proof Sheet is a simple and convenient way to make prints directly from a photo card without the need for a computer. A Proof Sheet, which may be several pages long, shows thumbnail views of photos stored on the photo card. The file name, index number, and date appear under each thumbnail.

After printing a Proof Sheet, fill in the circles with a pencil or black pen and place the Proof Sheet on the glass. The Proof Sheet is scanned and photo prints are generated automatically, without a computer.

1 Insert the photo card into the appropriate slot on your printer.

2 Press the **Proof Sheet** button.

The front panel displays the message:

Proof Sheet

1 = Print 2 = Scan

3 Press **1**.

The Proof Sheet prints.

If the photo card contains more than 20 photos, you will be prompted to select photos. You can select all photos, which will be printed on multiple pages, or the last 20 photos, which will be printed on a single page.

Note: You can use the Proof Sheet index number to select which photos to print. This number may be different from the number associated with the photo on your digital camera. If you add photos to, or delete photos from, your photo card, you will need to reprint the Proof Sheet to see the new index numbers.

complete the proof sheet

After you have printed a proof sheet (shown below), as described in **print a proof sheet**, you can select photos to be printed.

	photo proof sheet	hp psc 2170 all-in-one																															
3 simple steps to print photos from camera card																																	
step 1: to select photo(s), fill in bubble(s) underneath with a dark pen. <input type="radio"/> <input type="radio"/> <input type="radio"/>																																	
																																	
<table border="1" style="width: 100%; border-collapse: collapse;"> <tr> <td style="padding: 2px;"><input type="radio"/> 1 Sep 8 2001 DSCF0072.JPG</td> <td style="padding: 2px;"><input type="radio"/> 2 Sep 8 2001 DSCF0073.JPG</td> <td style="padding: 2px;"><input type="radio"/> 3 Sep 8 2001 DSCF0074.JPG</td> <td style="padding: 2px;"><input type="radio"/> 4 Sep 8 2001 DSCF0075.JPG</td> <td style="padding: 2px;"><input type="radio"/> 5 Sep 8 2001 DSCF0077.JPG</td> </tr> <tr> <td style="padding: 2px;"><input type="radio"/> 6 Sep 8 2001 DSCF0078.JPG</td> <td style="padding: 2px;"><input type="radio"/> 7 Sep 8 2001 DSCF0079.JPG</td> <td style="padding: 2px;"><input type="radio"/> 8 Sep 8 2001 DSCF0080.JPG</td> <td style="padding: 2px;"><input type="radio"/> 9 Sep 8 2001 DSCF0084.JPG</td> <td style="padding: 2px;"><input type="radio"/> 10 Sep 22 2001 DSCF0173.JPG</td> </tr> <tr> <td style="padding: 2px;"><input type="radio"/> 11 Sep 22 2001 DSCF0174.JPG</td> <td style="padding: 2px;"><input type="radio"/> 12 Sep 22 2001 DSCF0175.JPG</td> <td style="padding: 2px;"><input type="radio"/> 13 Sep 22 2001 DSCF0176.JPG</td> <td style="padding: 2px;"><input type="radio"/> 14 Sep 22 2001 DSCF0177.JPG</td> <td style="padding: 2px;"><input type="radio"/> 15 Sep 23 2001 DSCF0178.JPG</td> </tr> <tr> <td style="padding: 2px;"><input type="radio"/> 16 Sep 28 2001 DSCF0200.JPG</td> <td style="padding: 2px;"><input type="radio"/> 17 Sep 28 2001 DSCF0202.JPG</td> <td style="padding: 2px;"><input type="radio"/> 18 Sep 28 2001 DSCF0203.JPG</td> <td style="padding: 2px;"><input type="radio"/> 19 Sep 28 2001 DSCF0204.JPG</td> <td style="padding: 2px;"><input type="radio"/> 20 Sep 28 2001 DSCF0205.JPG</td> </tr> </table>			<input type="radio"/> 1 Sep 8 2001 DSCF0072.JPG	<input type="radio"/> 2 Sep 8 2001 DSCF0073.JPG	<input type="radio"/> 3 Sep 8 2001 DSCF0074.JPG	<input type="radio"/> 4 Sep 8 2001 DSCF0075.JPG	<input type="radio"/> 5 Sep 8 2001 DSCF0077.JPG	<input type="radio"/> 6 Sep 8 2001 DSCF0078.JPG	<input type="radio"/> 7 Sep 8 2001 DSCF0079.JPG	<input type="radio"/> 8 Sep 8 2001 DSCF0080.JPG	<input type="radio"/> 9 Sep 8 2001 DSCF0084.JPG	<input type="radio"/> 10 Sep 22 2001 DSCF0173.JPG	<input type="radio"/> 11 Sep 22 2001 DSCF0174.JPG	<input type="radio"/> 12 Sep 22 2001 DSCF0175.JPG	<input type="radio"/> 13 Sep 22 2001 DSCF0176.JPG	<input type="radio"/> 14 Sep 22 2001 DSCF0177.JPG	<input type="radio"/> 15 Sep 23 2001 DSCF0178.JPG	<input type="radio"/> 16 Sep 28 2001 DSCF0200.JPG	<input type="radio"/> 17 Sep 28 2001 DSCF0202.JPG	<input type="radio"/> 18 Sep 28 2001 DSCF0203.JPG	<input type="radio"/> 19 Sep 28 2001 DSCF0204.JPG	<input type="radio"/> 20 Sep 28 2001 DSCF0205.JPG											
<input type="radio"/> 1 Sep 8 2001 DSCF0072.JPG	<input type="radio"/> 2 Sep 8 2001 DSCF0073.JPG	<input type="radio"/> 3 Sep 8 2001 DSCF0074.JPG	<input type="radio"/> 4 Sep 8 2001 DSCF0075.JPG	<input type="radio"/> 5 Sep 8 2001 DSCF0077.JPG																													
<input type="radio"/> 6 Sep 8 2001 DSCF0078.JPG	<input type="radio"/> 7 Sep 8 2001 DSCF0079.JPG	<input type="radio"/> 8 Sep 8 2001 DSCF0080.JPG	<input type="radio"/> 9 Sep 8 2001 DSCF0084.JPG	<input type="radio"/> 10 Sep 22 2001 DSCF0173.JPG																													
<input type="radio"/> 11 Sep 22 2001 DSCF0174.JPG	<input type="radio"/> 12 Sep 22 2001 DSCF0175.JPG	<input type="radio"/> 13 Sep 22 2001 DSCF0176.JPG	<input type="radio"/> 14 Sep 22 2001 DSCF0177.JPG	<input type="radio"/> 15 Sep 23 2001 DSCF0178.JPG																													
<input type="radio"/> 16 Sep 28 2001 DSCF0200.JPG	<input type="radio"/> 17 Sep 28 2001 DSCF0202.JPG	<input type="radio"/> 18 Sep 28 2001 DSCF0203.JPG	<input type="radio"/> 19 Sep 28 2001 DSCF0204.JPG	<input type="radio"/> 20 Sep 28 2001 DSCF0205.JPG																													
<table border="1" style="width: 100%; border-collapse: collapse;"> <tr> <td style="padding: 2px;">step 2: select print options select only one choice per section</td> <td style="padding: 2px;"> <table style="width: 100%;"> <tr> <td>number of prints:</td> <td><input type="radio"/> 2 x 3</td> <td><input type="radio"/> 3 x 5</td> <td><input type="radio"/> 5 x 7</td> </tr> <tr> <td></td> <td><input type="radio"/> single</td> <td><input type="radio"/> 4 x 6</td> <td><input type="radio"/> 8 x 10</td> </tr> </table> </td> <td style="padding: 2px;"> <table style="width: 100%;"> <tr> <td>image size (in.):</td> <td><input type="radio"/> 2 x 3</td> <td><input type="radio"/> 3 x 5</td> <td><input type="radio"/> 5 x 7</td> <td><input type="radio"/> 8 x 10</td> </tr> </table> </td> <td style="padding: 2px;"> <table style="width: 100%;"> <tr> <td>paper size:</td> <td><input type="radio"/> 4 x 6</td> <td><input type="radio"/> 8 1/2 x 11</td> </tr> </table> </td> <td style="padding: 2px;"> <table style="width: 100%;"> <tr> <td>borders & frames:</td> <td><input type="radio"/> none</td> </tr> <tr> <td></td> <td><input type="radio"/> </td> </tr> <tr> <td></td> <td><input type="radio"/> </td> </tr> <tr> <td></td> <td><input type="radio"/> </td> </tr> <tr> <td></td> <td><input type="radio"/> </td> </tr> </table> </td> </tr> </table>			step 2: select print options select only one choice per section	<table style="width: 100%;"> <tr> <td>number of prints:</td> <td><input type="radio"/> 2 x 3</td> <td><input type="radio"/> 3 x 5</td> <td><input type="radio"/> 5 x 7</td> </tr> <tr> <td></td> <td><input type="radio"/> single</td> <td><input type="radio"/> 4 x 6</td> <td><input type="radio"/> 8 x 10</td> </tr> </table>	number of prints:	<input type="radio"/> 2 x 3	<input type="radio"/> 3 x 5	<input type="radio"/> 5 x 7		<input type="radio"/> single	<input type="radio"/> 4 x 6	<input type="radio"/> 8 x 10	<table style="width: 100%;"> <tr> <td>image size (in.):</td> <td><input type="radio"/> 2 x 3</td> <td><input type="radio"/> 3 x 5</td> <td><input type="radio"/> 5 x 7</td> <td><input type="radio"/> 8 x 10</td> </tr> </table>	image size (in.):	<input type="radio"/> 2 x 3	<input type="radio"/> 3 x 5	<input type="radio"/> 5 x 7	<input type="radio"/> 8 x 10	<table style="width: 100%;"> <tr> <td>paper size:</td> <td><input type="radio"/> 4 x 6</td> <td><input type="radio"/> 8 1/2 x 11</td> </tr> </table>	paper size:	<input type="radio"/> 4 x 6	<input type="radio"/> 8 1/2 x 11	<table style="width: 100%;"> <tr> <td>borders & frames:</td> <td><input type="radio"/> none</td> </tr> <tr> <td></td> <td><input type="radio"/> </td> </tr> <tr> <td></td> <td><input type="radio"/> </td> </tr> <tr> <td></td> <td><input type="radio"/> </td> </tr> <tr> <td></td> <td><input type="radio"/> </td> </tr> </table>	borders & frames:	<input type="radio"/> none		<input type="radio"/> 		<input type="radio"/> 		<input type="radio"/> 		<input type="radio"/> 
step 2: select print options select only one choice per section	<table style="width: 100%;"> <tr> <td>number of prints:</td> <td><input type="radio"/> 2 x 3</td> <td><input type="radio"/> 3 x 5</td> <td><input type="radio"/> 5 x 7</td> </tr> <tr> <td></td> <td><input type="radio"/> single</td> <td><input type="radio"/> 4 x 6</td> <td><input type="radio"/> 8 x 10</td> </tr> </table>	number of prints:	<input type="radio"/> 2 x 3	<input type="radio"/> 3 x 5	<input type="radio"/> 5 x 7		<input type="radio"/> single	<input type="radio"/> 4 x 6	<input type="radio"/> 8 x 10	<table style="width: 100%;"> <tr> <td>image size (in.):</td> <td><input type="radio"/> 2 x 3</td> <td><input type="radio"/> 3 x 5</td> <td><input type="radio"/> 5 x 7</td> <td><input type="radio"/> 8 x 10</td> </tr> </table>	image size (in.):	<input type="radio"/> 2 x 3	<input type="radio"/> 3 x 5	<input type="radio"/> 5 x 7	<input type="radio"/> 8 x 10	<table style="width: 100%;"> <tr> <td>paper size:</td> <td><input type="radio"/> 4 x 6</td> <td><input type="radio"/> 8 1/2 x 11</td> </tr> </table>	paper size:	<input type="radio"/> 4 x 6	<input type="radio"/> 8 1/2 x 11	<table style="width: 100%;"> <tr> <td>borders & frames:</td> <td><input type="radio"/> none</td> </tr> <tr> <td></td> <td><input type="radio"/> </td> </tr> <tr> <td></td> <td><input type="radio"/> </td> </tr> <tr> <td></td> <td><input type="radio"/> </td> </tr> <tr> <td></td> <td><input type="radio"/> </td> </tr> </table>	borders & frames:	<input type="radio"/> none		<input type="radio"/> 		<input type="radio"/> 		<input type="radio"/> 		<input type="radio"/> 			
number of prints:	<input type="radio"/> 2 x 3	<input type="radio"/> 3 x 5	<input type="radio"/> 5 x 7																														
	<input type="radio"/> single	<input type="radio"/> 4 x 6	<input type="radio"/> 8 x 10																														
image size (in.):	<input type="radio"/> 2 x 3	<input type="radio"/> 3 x 5	<input type="radio"/> 5 x 7	<input type="radio"/> 8 x 10																													
paper size:	<input type="radio"/> 4 x 6	<input type="radio"/> 8 1/2 x 11																															
borders & frames:	<input type="radio"/> none																																
	<input type="radio"/> 																																
	<input type="radio"/> 																																
	<input type="radio"/> 																																
	<input type="radio"/> 																																
step 3: place sheet on scanner glass at front right corner. Press proof sheet , then 2.																																	

- 1 Select the photos to print by filling in the circles located underneath the thumbnail images on the Proof Sheet with a dark pen.
- 2 Select the number of prints, image size, paper size, and frame style by filling in the circles in step 2 of the Proof Sheet.
- 3 Place the top of the Proof Sheet face down on the scanner glass in the front-right corner with the sides of the originals touching the right and front edges, then close the lid.

print photos by scanning a proof sheet

After you have printed and completed a Proof Sheet (see **print a proof sheet** on page 19 and **complete the proof sheet** on page 19), you can print photos from the photo card by scanning the proof sheet.

Note: You may want to use a photo print cartridge for superior print quality. With the color and photo print cartridges installed, you have a six-ink system. See **work with print cartridges** on page 38 for more information.

- 1 Make sure that the photo card used to print the proof sheet is inserted into the appropriate slot on your HP PSC.
- 2 Load the appropriate paper, such as photo paper, in the paper tray.
- 3 Place the proof sheet on the glass.
- 4 Press **Proof Sheet**, then press **2**.
The glass is scanned and the HP PSC prints the photos you specified on the Proof Sheet.

print selected photos directly from a photo card

Note: When printing photos, you should select options for the correct paper type and photo enhancement. You may also want to use the photo print cartridge for superior print quality. See **work with print cartridges** on page 38 for more information.

You can print:

- Selected photos
- More than one copy of a selected photo
- A Digital Print Order Format (DPOF) file created by your camera

print individual photos

If you don't know the photo index number, you may want to print a photo Proof Sheet before selecting individual photos to print.

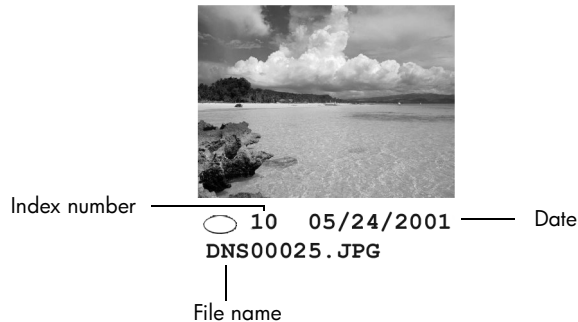

- 1 Insert the photo card into the appropriate slot on your printer.
The Photo Card button lights up.
- 2 Press **2** to Print Photos.
- 3 Press **Enter** to select **Photos on Card**.
- 4 Press **▶** until **Select Photos** appears, then press **Enter**.
- 5 Enter the photo index numbers for the photos you want to print.
A comma is inserted automatically as the cursor advances to the right.
Note: You can erase index number by pressing **◀**. As the bottom line gets filled, the data entry field scrolls left to show the number as it is entered.
- 6 Press **Enter** when you are finished entering the photo index numbers.

- 7 Press **Options** or **Photo Card** repeatedly to scroll through, and modify, Photo Card options.
- 8 Press **Start Black** or **Start Color**.

print a DPOF file

The Digital Print Order Format (DPOF) is an industry-standard print file request that can be created by some digital cameras. See your digital camera documentation to see if it supports Digital Print Order Format (DPOF).

The DPOF file is stored by the digital camera on a photo card and specifies the following information:

- Which photos to print
 - The quantity of each photo to be printed
- 1 Insert the photo card into the appropriate slot on your printer.
 - 2 Press **Photo Card**, then press **2**.
 - 3 Press **Options** or **Photo Card**, then press **Enter** to select **Print What?**
The Print What? option is only available when the photo card that has been inserted contains a DPOF file.
 - 4 Press **Enter** to select **Use DPOF**.
 - 5 Press **Options** or **Photo Card** repeatedly to scroll through, and modify, Photo Card options.
 - 6 Press **Start Black** or **Start Color**.

how to print the best quality photos

You can improve the quality of the photos you print with your HP PSC by using a photo print cartridge. Remove the black print cartridge and insert the photo print cartridge in its place. With the color print cartridge and photo print cartridge installed, you have a six-ink system, which provides better quality photos.

For more information, see **order print cartridges** on the inside of the back cover, and **work with print cartridges** on page 38.

options menu for photo card and proof sheet commands

When you load a photo card, the following options become available in the options menu. Menu options vary depending on whether you are printing a DPOF file or photos.

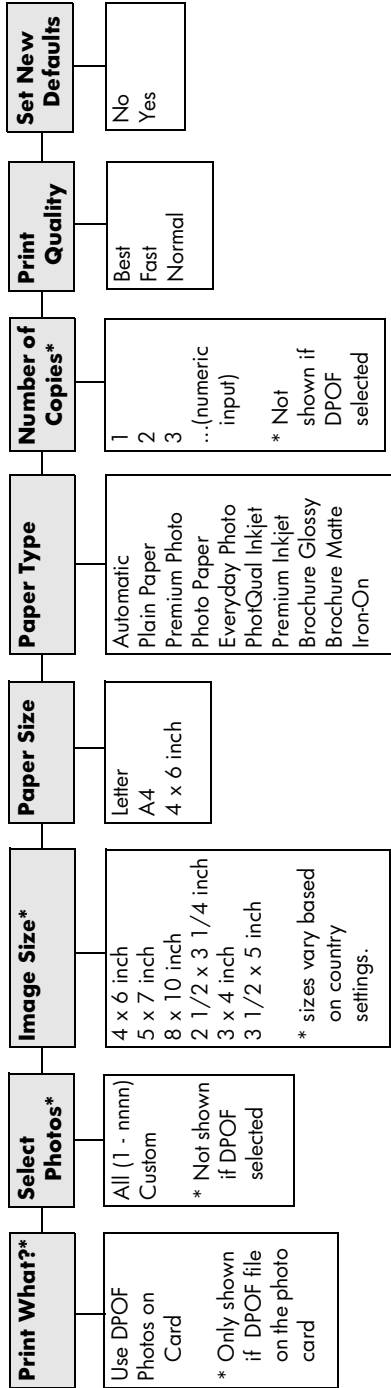

Use when the **Photo Card** button is illuminated.
Press **Options** or **Photo Card** to display the menu options.
Press **Left Arrow** and **Right Arrow** to move to the setting you want.
Press **Enter** to select the displayed setting.

When you press **Proof Sheet**, the following options are available if there are more than 20 photos on the photo card:

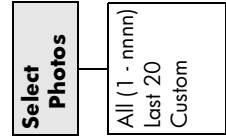

5

use the copy features

The copy features let you do the following:

- Produce high-quality color and black-and-white copies using a variety of paper types and sizes, including iron-on transfers.
- Reduce or enlarge the size of the copies you make from 25% to 400% of the copy's original size. (Percentages vary by model.)
- Make the copy lighter or darker, adjust the color intensity, select the number of copies, and specify the quality of the copies you make.
- Use special copying features to create a poster, make many sizes of photos, make high-quality copies of photos using special photo paper, or to create transparencies.

Note: When copying a photo, you must select options for the correct paper type and photo enhancement. You may also want to use the photo print cartridge for superior print quality. With the color and photo print cartridges installed, you have a six-ink system. See **work with print cartridges** on page 38 for more information.

Note: You can only copy to A4 or Letter-sized paper.

make copies

You can make copies using the front panel of your HP PSC or by using the HP PSC software on your computer. Many copy features are available using either method. However, you may find that the software offers easier access to special copy features.

All copy settings that you select on the front panel are reset **two minutes** after the HP PSC completes the copy, unless you save the settings as the default settings.

make a copy

- 1 Load your original on the glass.
- 2 Press **Copy**, if not already lit.
- 3 Press **Start Black** or **Start Color**.

increase copy speed or quality



The HP PSC provides three options that affect copy speed and quality.

- **Best** produces the highest quality for all paper and eliminates the banding (striping) effect that sometimes occurs in solid areas. **Best** copies more slowly than the other quality settings.
- **Normal** delivers high-quality output and is the recommended setting for most of your copying. **Normal** copies faster than **Best**.
- **Fast** copies faster than the **Normal** setting. The text is of comparable quality to the **Normal** setting, but the graphics may be of lower quality. Using **Fast** also cuts down on the frequency of replacing your print cartridges, because it uses less ink.

- 1 Load your original on the glass.
- 2 Press **Copy**, if not already lit.
- 3 Press **Options** until **Copy Quality** appears.
- 4 Press  until the desired quality appears.
- 5 Press **Start Black** or **Start Color**.

set the number of copies

You can set the number of copies using the front panel.



- 1 Press **Copy**, if not already lit.
- 2 Press **Options** until **Number of Copies** appears.
- 3 Press  or  to select the number of copies.
If you hold down either of the arrow buttons, the number of copies changes by increments of 5 to make it easier to set a large number of copies. You can also enter the number of copies using the keypad.
- 4 Press **Start Black** or **Start Color**.

reduce or enlarge a copy

You can reduce or enlarge a copy of an original using **Reduce/Enlarge**.

Note: You can only copy to A4 or Letter-sized paper.

For more information about additional copy options such as **Fit to Page** and **Poster**, see **perform special copy jobs** on page 28.

- 1 Press **Copy**, if not already lit.
- 2 Press **Options** until **Reduce/Enlarge** appears.
- 3 Press  to choose a **Reduce/Enlarge** option.
If you select the **Custom** option, press **Enter**, then press  or  to select a percentage. You can also enter the percentage using the keypad. Press **Enter** when the desired percentage is displayed.
- 4 Press **Start Black** or **Start Color**.

make copies lighter or darker

Use **Lighter/Darker** to adjust the lightness and darkness of the copies you make.

- 1 Press **Copy**, if not already lit.
- 2 Press **Options** until **Lighter/Darker** appears.
The range of **Lighter/Darker** values appears as a circle on a scale on the front-panel display.
- 3 Press ◀ to lighten the copy or ▶ to darken it.
The circle moves to the left or right, depending on the button you press.
- 4 Press **Start Black** or **Start Color**.

change color intensity

You can adjust color intensity to make colors on your copy more vivid or more subtle.

- 1 Press **Copy**, if not already lit.
- 2 Press **Options** until **Color Intensity** appears.
The range of color intensity values appears as a circle on a scale on the front-panel display.
- 3 Press ◀ to make the image more pale or ▶ to make the image more vivid.
The circle moves to the left or right, depending on the button you press.
- 4 Press **Start Black** or **Start Color**.

enhance text sharpness and photo colors

Use **Text** enhancements to sharpen edges of black text. Use **Photo** for photographs or pictures to enhance light colors that may otherwise appear white. Use **Mixed** when your original has both text and graphics.

Text enhancement is the default option. You can turn off **Text** enhancement by selecting **Photo** or **None** if the following occur:

- Stray dots of color surround some text on your copies.
- Large, black typefaces look splotchy (not smooth).
- Thin, colored objects or lines contain black sections.
- Horizontal grainy or white bands appear in light- to medium-gray areas.

- 1 Press **Copy**, if not already lit.
- 2 Press **Options** until **Enhancements** appears.
- 3 Press ▶ until the desired enhancement (**Text**, **Photo**, **Mixed**, or **None**) appears.
- 4 Press **Start Black** or **Start Color**.

change settings for all copy tasks

Save the copy settings you use most often by setting them as the default.

- 1 Make any desired changes to the copy **Options**.
- 2 Press **Options** until **Set New Defaults** appears.
- 3 Press ▶ until **Yes** appears.

- 4 Press **Enter** to set the option as a default.
Your settings are saved as the default settings.



perform special copy jobs

In addition to supporting standard copying, your HP PSC can also do the following:

- **copy a photo**
- **fit a copy to the page**
- **print several copies on one page**
- **make a poster**
- **prepare a color t-shirt transfer**

copy a photo

When copying a photo, you should select options for the correct paper type and photo enhancement. You may also want to use the photo print cartridge for superior print quality. See **work with print cartridges** on page 38 for more information.

- 1 Load the photo on the glass.
- 2 If you are using photo paper, load it in the paper tray.
- 3 Press **Copy**, if not already lit.
- 4 Press **Options** until **Paper Type** appears.
- 5 Press  until the desired paper option appears.
The default paper type is Automatic, which means the HP PSC will automatically detect and determine the paper type. You can choose the specific paper type by pressing  until the desired paper type appears.
- 6 Press **Options** until **Enhancements** appears.
- 7 Press  until **Photo** appears.
- 8 Press **Start Black** or **Start Color**.

Tip: To enlarge a photo automatically to a full page, use the **Fit to Page** feature.

fit a copy to the page

Use **Fit to Page** when you want to automatically enlarge or reduce your original to fit the paper size you have loaded. You can enlarge a small photo to fit a full-size page, as shown below. Using **Fit to Page** may also prevent unwanted cropping of text or images around the margins.

Tip: Make sure that the glass is clean and the original has been placed in the bottom-right corner of the glass.

Original



Fit to Page

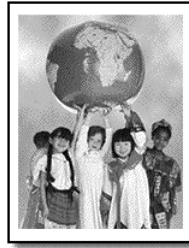

- 1 Load the original on the glass.
- 2 Press **Copy**, if not already lit.
- 3 Press **Options** until **Reduce/Enlarge** appears.
- 4 Press  until **Fit to Page** appears.
- 5 Press **Start Black** or **Start Color**.

print several copies on one page

You can place multiple copies of an original on one page by selecting a photo size and then selecting the number of copies you want.



There are several common photo sizes available from the **Reduce/Enlarge** option, which you access from the **Options** button. After you select one of the available sizes by pressing **Enter**, you may be prompted to select the number of copies that can be placed on the page if there is room for more than one.

Original

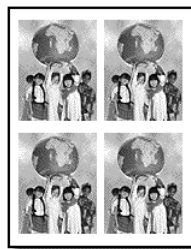

Copy





- 1 Load the original on the glass.
- 2 Press **Copy**, if not already lit.
- 3 Press **Options** until **Reduce/Enlarge** appears.
- 4 Press  until the desired photo size appears, then press **Enter**.
- 5 Press  to select the maximum number of images that will fit on the page or one image per page.
Some larger sizes do not prompt you for a number of images. In this case, only one image is copied to the page.
- 6 Press **Start Black** or **Start Color**.

Tip: If the selected number of photos will not fit on the page, an error message appears. Turn the original sideways (90 degrees) on the glass and start the copy again.

make a poster

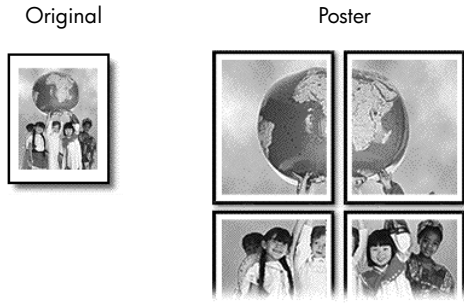
When you use the Poster feature you divide your original into sections, then enlarge the sections so you can assemble them into a poster.



- 1 Load the original on the glass.
- 2 Press **Copy**, if not already lit.
- 3 Press **Options** until **Reduce/Enlarge** appears.
- 4 Press  until **Poster** appears, then press **Enter**.
The default poster size is 2-pages wide.
- 5 Do one of the following:
 - Press **Enter** to select the default poster size.
 - Press  to select other poster size options, and then press **Enter**.
- 6 Press **Start Black** or **Start Color**.

Tip: After you select the poster width, the HP PSC adjusts the length automatically to maintain the proportions of the original. If the original cannot be enlarged to the selected poster size, an error message appears that tells you the number of pages wide that are possible. Select a smaller poster size and make the copy again.

prepare a color t-shirt transfer

You can copy an image or text onto a T-shirt transfer, then iron it onto a T-shirt.



Tip: We recommend that you practice applying a T-shirt transfer on an old garment first.

- 1 Load the original on the glass.
- 2 Load the T-shirt transfer paper in the paper tray.
- 3 Press **Copy**, if not already lit.
- 4 Press **Options** until **Paper Type** appears.
- 5 Press  until **Iron-On** appears.
Selecting this option automatically copies a mirror-image of your original so that it appears properly on the T-shirt.
- 6 Press **Start Black** or **Start Color**.

stop copying

- ▶ To stop copying, press **Cancel** on the front panel.

copy options

The following diagram shows the copy options that are available when the **Options** button is selected.

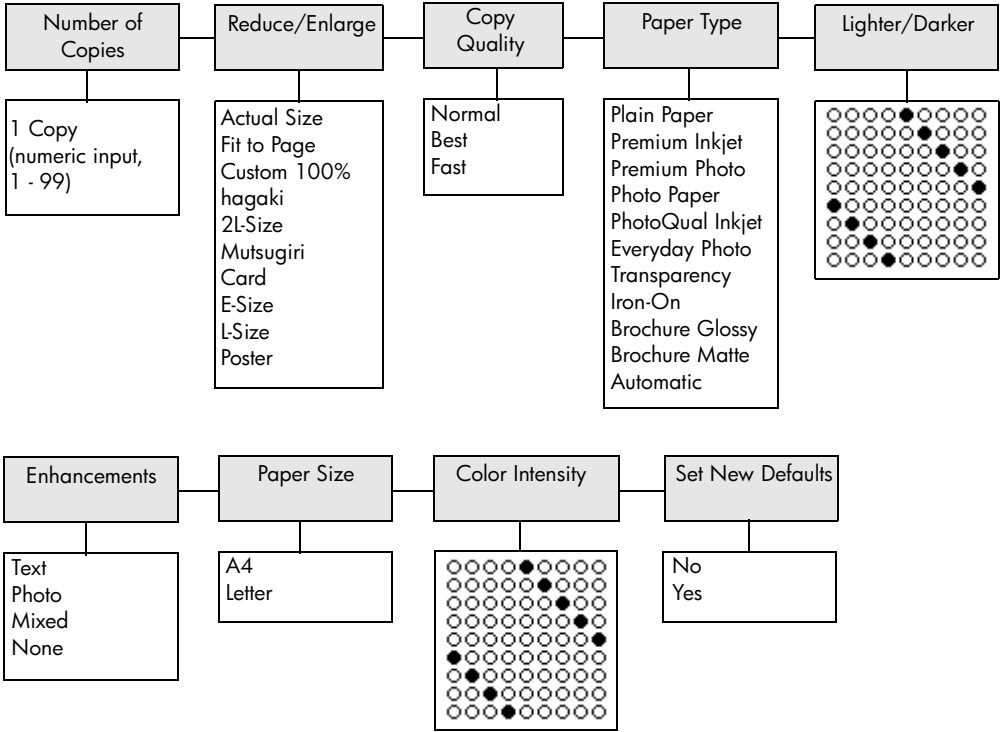

Press **Options** or **Copy** to display the copy options.
 Press **◀** and **▶** to move to the setting you want.
 Press **Enter** to select the displayed setting.

6

use the scan features

Scanning is the process of converting text and pictures into an electronic format for your computer. You can scan just about anything:

- Photos
- Magazine articles
- Text documents (PC only)
- 3D objects (be careful not to scratch the glass) to put into catalogs and flyers

Because the scanned image is an electronic format, you can bring it into your graphics program and modify it to suit your needs. You can do the following:

- Scan text from an article into your word processor and quote it in a report, saving you a lot of retyping. (PC only)
- Scan in a logo and use it in your publishing software, allowing you to print business cards and brochures for yourself.
- Scan in photos of your kids and e-mail them to relatives, create a photographic inventory of your house or office, or create an electronic scrapbook.

Tip: To use the scan features, your HP PSC and computer must be connected and turned on. The HP PSC software must also be installed and running on your computer prior to scanning. To verify that the HP PSC software is running on Windows, look for a status icon in the system tray. On a Macintosh, the HP PSC software is always running.

This section contains the following topics:

- **scan an original**
- **stop scanning**

For more information about scanning your pictures from the HP PSC software, see **scan pictures and documents** in the HP Photo & Imaging Help for more information.

scan an original

scan to the hp photo & imaging gallery

You can start a scan from your computer or from your HP PSC.

to scan an original, from the front panel, to your Windows computer

- 1 Load your original on the glass.
- 2 Press **Scan**, if not already lit.
- 3 Press **Start Black** or **Start Color**.

A scan of the original appears in the HP Image Viewer.

- 4 In the HP Preview window, you can edit the scanned image. When you have finished, click **Accept**.

For more information about making changes to an image during the preview, see **adjust an image during the preview** in **scan pictures and documents** in the HP Photo & Imaging Help for more information.

The HP PSC does a final scan of the original and sends the image to the HP Photo & Imaging Gallery.

See **manage images** in **how to use the software** for more information about using the HP Photo & Imaging Gallery.

to scan an original, from the front panel, to your Macintosh computer

- 1 Load your original on the glass.

For more information, see **load originals**.

- 2 Press **Scan**, if not already lit.

- 3 Press **Start Black** or **Start Color**.

The HP PSC scans the original and sends the image to the HP Photo and Imaging Gallery.

See the HP Photo and Imaging Gallery online help for more information.

scan to a different software program

If you prefer to scan your document to a software program other than the HP Photo & Imaging Gallery, you can choose a different program from the **Scan To** list that appears in the front-panel display. The HP PSC scans the document, launches the selected software program, and displays the scanned image in that program.

Note: If a software application installed on your PC doesn't appear in the **Scan To** list, then the hp psc doesn't support this application.

- 1 Load your original.

For more information, see **load originals** on page 9.

- 2 Press **Scan**, if not already lit.

- 3 Press **Options**.

- 4 Press  to scroll through the **Scan To** list until the desired scan-to software program appears.

- 5 Press **Start Black** or **Start Color**.

The HP PSC scans your original and displays it in the selected software program.

stop scanning

You can stop a scan by pressing the **Cancel** button located on the front panel.

learn more

For Windows, see **scan pictures and documents** in **how to use the software** in the HP Photo & Imaging Help to learn more about:

- scanning pictures or documents
- scanning documents using optical character recognition (Readiris OCR software) to create editable text
- scanning from other programs
- adjusting scanned images
- changing scan settings

For Macintosh, see the Scan chapter in the HP PSC 2170 Series section of the HP Photo and Imaging Help for more information about:

- scanning pictures or documents
- scanning from other programs
- adjusting scanned images
- changing scan settings

7

maintain your hp psc

This section provides instructions for keeping your HP PSC in top working condition. Perform these maintenance procedures as necessary.

clean the glass

Dirty glass, from fingerprints, smudges, hair, and so on, slows down performance and affects the accuracy of features such as Fit to Page and Copy.

- 1 Turn off the unit, unplug the power cord, and raise the lid.
- 2 Clean the glass with a soft cloth or sponge slightly moistened with a nonabrasive glass cleaner.

Caution! Do not use abrasives, acetone, benzene, or carbon tetrachloride on the glass; these can damage it. Do not place liquids directly on the glass. They may seep under it and damage the unit.

- 3 Dry the glass with a chamois or cellulose sponge to prevent spotting.

clean the lid backing

Minor debris can accumulate on the white document-backing located underneath the unit's lid.

- 1 Turn off the unit, unplug the power cord, and raise the lid.
- 2 Clean the white document-backing with a soft cloth or sponge slightly moistened with a mild soap and warm water.
- 3 Wash the backing gently to loosen debris; do not scrub the backing.
- 4 Dry the backing with a chamois or soft cloth.

Caution! Do not use paper-based wipes as these may scratch the backing.

- 5 If this does not clean the backing well enough, repeat the previous steps using isopropyl (rubbing) alcohol, and wipe the backing thoroughly with a damp cloth to remove any residual alcohol.

clean the exterior

Use a soft, damp, lint-free cloth to wipe dust, smudges, and stains off the case. The interior of the unit does not require cleaning. Keep fluids away from the interior of the unit as well as the front panel.

Note: To avoid damage to painted parts of the unit, do not use alcohol or alcohol-based cleaning products on the front panel or the lid of the unit.

work with print cartridges

To ensure the best print quality from your HP PSC, you will need to perform some simple maintenance procedures, and when prompted by a front-panel message, replace the print cartridges.

print a self-test report

If you are experiencing problems with printing, before cleaning or replacing the print cartridges, you should print a self-test report. This report provides useful information about your print cartridges, including status information.

- 1 Press **Setup**.
- 2 Press **1**, then press **2**.
This selects **Print Report**, and then selects **Self-Test**.
A self-test report is printed for your HP PSC.

handle print cartridges

Before you replace or clean a print cartridge, you should know the part names and how to handle the print cartridge.

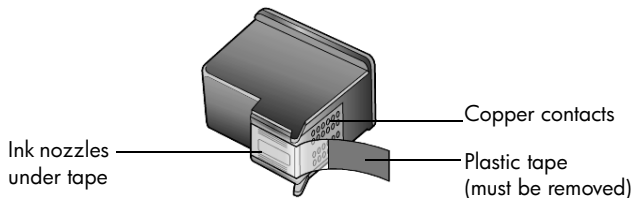

Do not touch the copper contacts or the ink nozzles

use the print cartridge protector

When you purchase a photo print cartridge, you also receive a print cartridge protector. The print cartridge protector is designed to keep your print cartridge secure when it is not being used. Whenever you remove a print cartridge from the printer, store it in the print cartridge protector that came with your printer.

- To insert a print cartridge into the print cartridge protector, slide the print cartridge into the print cartridge protector at a slight angle and snap it securely into place.
- To remove the print cartridge from the print cartridge protector, press down and back on the top of the print cartridge protector to release the print cartridge, then slide the print cartridge out of the print cartridge protector.

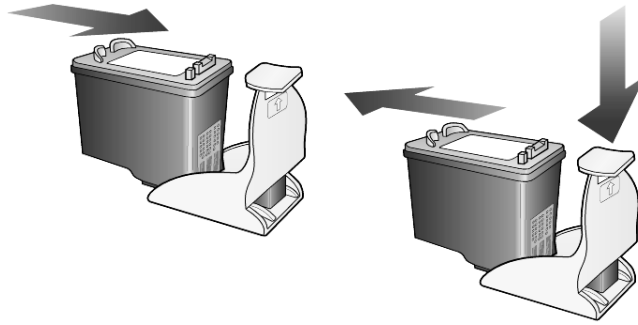

replace the print cartridges

Front-panel display messages appear to let you know that you should replace your print cartridges.

You may also need to replace a print cartridge when you want to use the photo print cartridge for printing high-quality photos.

See **order print cartridges** on the inside back cover for information on ordering replacement print cartridges.

- 1 Turn on the unit, then open the print-carriage access door by lifting the handle until the door locks into place.

The print carriage moves to the center of the unit.

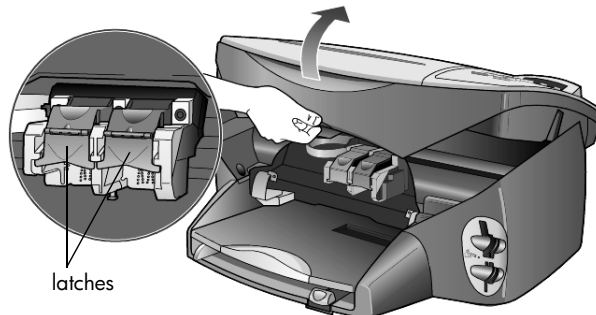

- 2 After the carriage stops moving, lift the latch to release the print cartridge, then pull it toward you out of its slot.

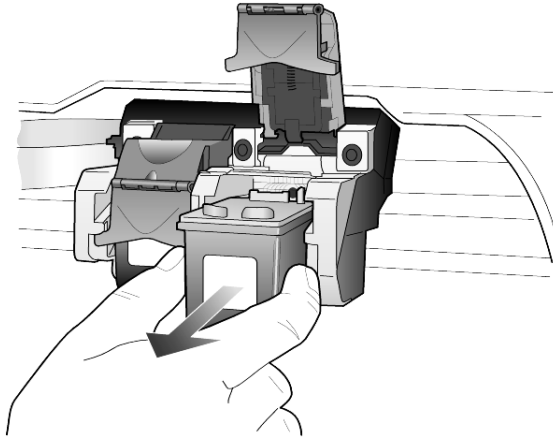

- 3 If you are removing the black print cartridge in order to install the photo print cartridge, store it in the print cartridge protector.
- 4 Remove the new print cartridge from its packaging and, being careful to touch only the black plastic, gently remove the plastic tape.

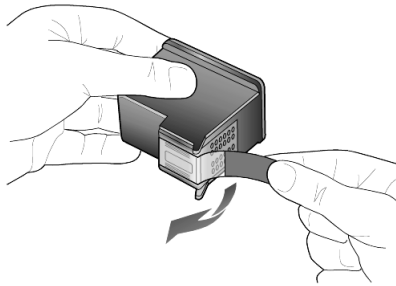

Caution! Do not touch the copper contacts or ink nozzles.

- 5 Push the new print cartridge into the appropriate slot until it clicks into place.
The tri-color print cartridge goes on the left and the black or photo print cartridge goes on the right.

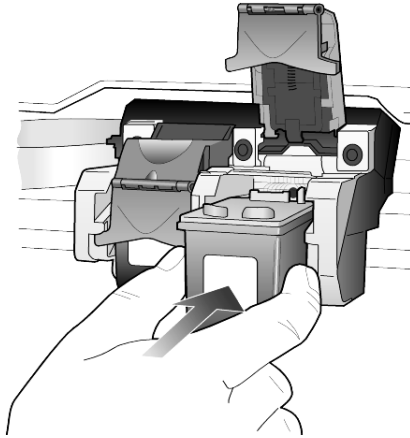

- 6 Pull the end of the latch toward you, press down until it stops, and then release. Make sure the latch catches below the bottom tabs.

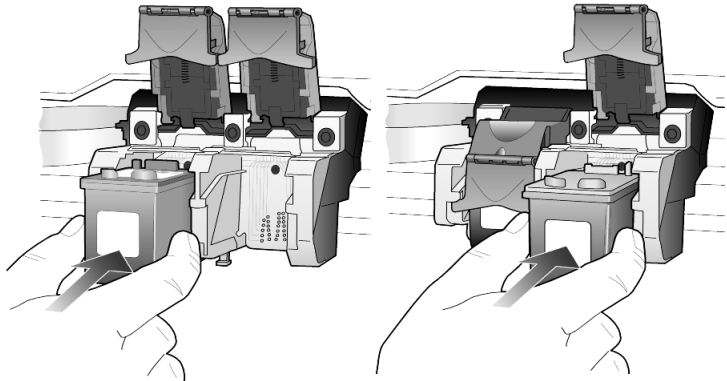

- 7 Close the print-carriage access door.

align the print cartridges

The HP PSC prompts you to align cartridges every time you install or replace a print cartridge. Aligning the cartridges ensures high-quality output.

To align the print cartridges when prompted:

- 1 Press **Enter** on the front panel.
A page of patterns is printed. The cartridges are aligned correctly. Recycle or discard the page.

To align the cartridges at any other time:

- 1 Press **Setup**.
- 2 Press **2**, then press **2**.
This selects **Maintenance**, and then selects **Align Print Cartridges**.
A page of patterns is printed. The cartridges are aligned correctly. Recycle or discard the page.

clean the print cartridges

Use this feature when the Self-Test Report shows streaking or white lines through any of the colored bars. Do not clean print cartridges unnecessarily. This wastes ink and shortens the life of the ink nozzles.

1 Press **Setup**.

2 Press **2**, then press **1**.

This selects the **Maintenance** menu, and then selects the **Clean Print Cartridges** option.

If copy or print quality still seem poor after you clean the print cartridges, replace the print cartridge that is affected.

troubleshooting print cartridge problems

Refer to the HP PSC Troubleshooting in the HP Photo & Imaging Help for information on problems with print cartridges. In the Search tab, enter “incorrect”, then click List Topics. The “Incorrect print cartridge” topic describes how to determine which print cartridge is having a problem.

restore factory defaults

You can restore the original factory settings to what they were when you purchased your HP PSC. Choosing to restore your factory defaults restores all settings, except date information.

You can perform this process from the front panel only.

1 Press **Setup**.

2 Press **2**, then press **3**.

This selects **Maintenance**, and then selects **Restore Factory Defaults**.

The factory default settings are restored.

set the power save time

The bulb in your HP PSC remains on for a specified period so that the unit is immediately ready to respond to your request. When the HP PSC has not been used within that specified period, it turns the bulb off to preserve power and displays **Power Save On** in the front-panel display. (You can exit this mode by pressing any button on the front panel.)

Your unit is automatically set to enter power-save mode after 12 hours. Follow these steps if you want the HP PSC to enter this mode earlier.

1 Press **Setup**.

2 Press **2**, then press **5**.

This selects **Maintenance**, and then selects **Power Save Mode Time**.

3 Press  until the desired time appears, then press **Enter**.

set scroll speed

The **Scroll Speed** option lets you control the rate that text messages appear in the front-panel display. You can choose **Normal**, **Fast**, or **Slow**. The default is **Normal**.

- 1 Press **Setup**.
- 2 Press **2**, then press **6**.
This selects **Maintenance**, and then selects **Set Scroll Speed**.
- 3 Press **▶** until the desired speed appears, then press **Enter**.

set the prompt delay time

The **Prompt Delay** option lets you control the amount of time before a message is displayed in the front-panel display. You can choose **Normal**, **Fast**, or **Slow**. The default is **Normal**.

- 1 Press **Setup**.
- 2 Press **2**, then press **8**.
This selects **Maintenance**, and then selects **Set Prompt Delay Time**.
- 3 Press **▶** until the delay time appears, then press **Enter**.

setup menu options

The following options are available from the **Setup** button.

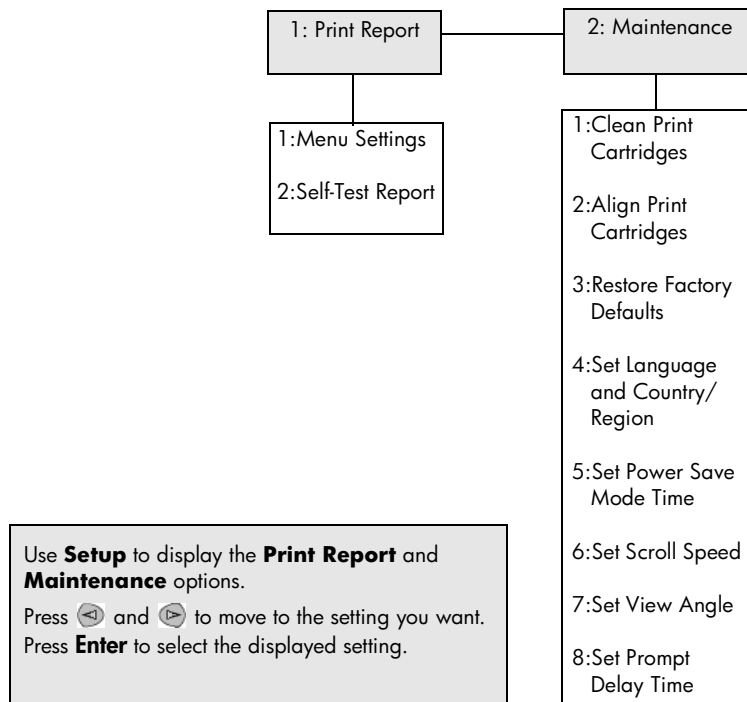

8

additional setup information

This section covers how to handle messages that may or may not appear during installation, how to set up the connection between your computer and your HP PSC, and how to add and remove the HP PSC software. The standard installation instructions are provided in your Setup Poster, which you should keep for later use.

If the HP Director displays all of the icons in the example below, then the software has been successfully installed.

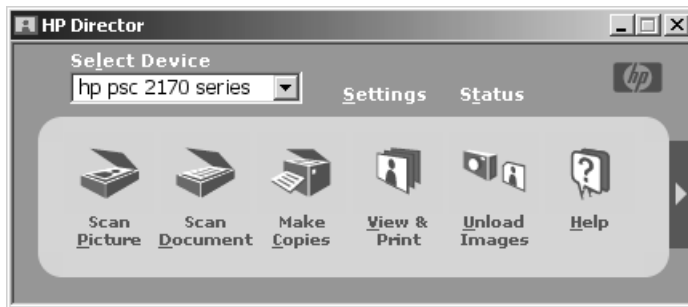

possible installation problems

If you follow the instructions in the Setup Poster correctly, you should not have any problems with the installation of your HP PSC. If you do not follow the instructions, you may see any of the following problems:

If you installed the hp psc software as requested on the setup poster and Microsoft's New Hardware Found message did not appear

If you are a Windows 98/2000/ME/XP user, a series of Microsoft New Hardware Found messages should have appeared on your screen after software installation and after the HP PSC was connected to your computer.

If the Microsoft messages did not appear, try the following:

- Verify that you are using a full-speed (12 Mbps) USB cable and that it does not exceed 3 meters in length (9.8 feet).
- Verify that the computer is USB-ready. For more information about determining whether your computer is USB-ready, see your computer's documentation or check with the computer's manufacturer.
- Verify that the cable is plugged fully into your HP PSC and directly connected to the USB port on your computer. After the cable is connected properly, turn your HP PSC off and then on again.

- Turn your HP PSC off and then on again, then restart your computer.
- If the previous steps do not solve the problem, remove and reinstall the software. For more information, see **remove and reinstall your hp psc software** on page 48.

If you set up your hp psc and connected it to your computer before installing the software and the New Hardware Message appears

If you are a Windows 98/2000/ME/XP user, you may see one of the following dialog boxes:



To avoid errors, install the HP PSC software before you connect the HP PSC to your computer. If one of the above messages appeared *and* you clicked **Next** or **OK**, do the following:

- 1 Press **Esc** on your keyboard to exit.
- 2 Turn off your HP PSC.
- 3 Disconnect the HP PSC from your computer (detach the USB cable).
- 4 Follow the software installation steps outlined in the Setup Poster that came with your HP PSC.

If the previous version installed message appears

If you receive a message that you have a previously installed version, you will see a message asking if you want to install a second version or remove the existing version.

If your computer is unable to communicate with your HP PSC

If communication cannot be established between your computer and HP PSC (for example, the HP PSC status icon has the yellow error triangle), try the same tasks outlined under **if you installed the hp psc software as requested on the setup poster and Microsoft's New Hardware Found message did not appear** on page 45.

Note: You may also want to refer to the readme file for more information on possible installation problems. On Windows, you can access the readme file from the Start button on the taskbar; select **Programs, Hewlett-Packard, hp psc 2000 series, View the Readme File**. On Macintosh, you can access the readme file by double-clicking on the icon located in the top-level folder of the HP PSC software CD-ROM.

set the language and country/region

Usually, the language and country or region are set when you install the HP PSC. If you set the country/region or language incorrectly during installation, use the following procedure.

- 1 Press **Setup**.
- 2 Press **2**, then press **4**.
This selects **Maintenance**, and then selects **Set Language & Country/Region**.
You are prompted with a list of languages. You can also scroll through the languages using ◀ or ▶.
- 3 Using the keypad, enter the two-digit number for the desired language.
- 4 When prompted, press **Enter** for Yes or **Cancel** for No.
You are prompted with all the countries/regions for the selected language. You can also scroll through the countries/regions using ◀ or ▶.
- 5 Using the keypad, enter the two-digit number for the desired country/region.
- 6 When prompted, press **Enter** for Yes or **Cancel** for No.
- 7 You can confirm the language and country/region by printing a Self-Test Report, as follows:
 - a. Press **Setup**.
 - b. Press **1**, then press **2**.
This selects **Print Report**, and then selects **Self-Test Report**.

set the front-panel view angle

If you have difficulty seeing the text in the front-panel display, you may need to change the view angle. The **View Angle** option lets you control the viewing angle of the text in the front-panel display. You can change the angle so that it displays text best when you view it from a standing position or from a seated position.

- 1 Press **Setup**.
- 2 Press **2**, then press **7**.
This selects **Maintenance**, and then selects **View Angle**.
- 3 Press **Enter**, press ◀ or ▶ until the text in the front-panel display appears as desired, then press **Enter**.

connect your hp psc to your computer

Your HP PSC supports HOT Swapping, meaning you can connect to the HP PSC while the power is on at your computer and on the HP PSC.

Note: HP recommends that you install the HP PSC software before attempting to HOT Swap your HP PSC.

connect your usb port

Connecting your computer to your HP PSC with USB is straightforward. Simply plug one end of the USB cable into the back of your computer and the other in the back of the HP PSC.

Note: HP recommends a USB cable of 3m or less.

what works	what does not work
Plugging into the USB port on your computer	Plugging into the USB port located on the keyboard
Plugging into a powered hub that is connected to the USB port on your computer	Plugging into a non-powered USB hub

Note: AppleTalk is not supported.

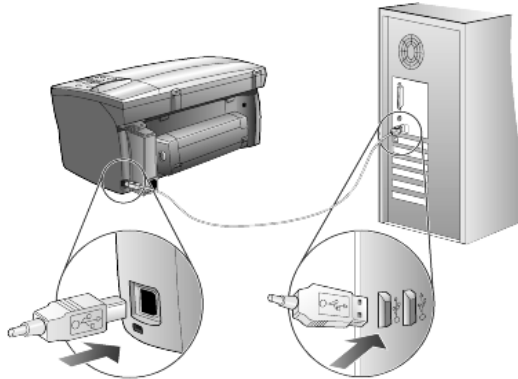

connecting to the USB port on your computer

connect your hp psc to more than one computer

You can connect more than one computer to your HP PSC by using a powered hub. Both computers must have the HP PSC software installed. Connect each computer to the hub, then connect the hub to the HP PSC.

remove and reinstall your hp psc software

Do *not* simply delete the HP PSC program files from your hard drive. Be sure to remove them properly using the uninstall utility provided in the HP PSC program group.

to uninstall from a Windows computer

- 1 On the Windows taskbar, click **Start**, choose **Programs** or **All Programs** (XP), choose **Hewlett-Packard**, choose **hp psc 2000 series**, then choose **uninstall software**.
- 2 Follow the directions on the screen.
- 3 If you are asked whether you would like to remove shared files, click **No**. Other programs that use these files may not work properly if the files are deleted.
- 4 After the program finishes removing the software, disconnect your HP PSC, and restart your computer.
- 5 To reinstall the software, insert the HP PSC 2170 Series CD-ROM into your computer's CD-ROM drive, and follow the instructions that appear.
- 6 After the software is installed, connect and turn on your HP PSC.

to uninstall from a Macintosh computer

- 1 Double-click on **Applications:HP All-in-One Software** folder.
- 2 Double-click on **Uninstaller**.
- 3 Follow the directions that appear on the screen.
- 4 After the program finishes removing the software, disconnect your HP PSC, and restart your computer.
- 5 To re-install the software, insert the HP PSC 2170 Series CD-ROM into your computer's CD-ROM drive, and follow the instructions that appear.
Note: When re-installing the software, follow the instructions on the Setup Poster. Do not connect the HP PSC to your computer until after you have completed the software installation.



technical information

system requirements

The following specifications are subject to change without notice.

PC Requirements		
Item	Minimum	Recommended
Processor Windows 98 Windows 98SE Windows 2000 Windows Millennium Edition Windows XP	Any Intel Pentium II, Celeron, or compatible processor	Intel Pentium III or higher
RAM Windows 98 Windows 98SE Windows 2000 Windows Millennium Edition Windows XP	64 MB	128 MB or more
Disk space needed for installation	600 MB	
Additional disk space needed for scanned images	50 MB	
Monitor	SVGA 800 x 600 with 16-bit color	
Media	CD-ROM drive	
I/O	Available USB port	
Internet access		Recommended
Sound card		Recommended
Other	I.E. 5.0 or higher Adobe Acrobat 4 or higher	

Macintosh Requirements		
Item	Minimum	Recommended
Processor	G3 Processor	G4 Processor or higher
RAM Macintosh OS 9 Macintosh OS X	64 MB 128 MB	128 MB 256 MB
Disk space needed for installation	200 MB	
Additional disk space needed for scanned images	50 MB	
Monitor	SVGA 800 x 600	
Media	CD-ROM drive	
I/O	Available USB port	
Internet access		Recommended
Sound card		Recommended

paper specifications

This section contains the following topics:

- **paper-tray capacities**
- **paper sizes**

paper-tray capacities

Type	Paper Weight	Input Tray ¹	Output Tray ²
Plain paper	16 to 24 lb. (60 to 90 gsm)	100	50 black, 20 color
Legal paper	20 to 24 lb. (75 to 90 gsm)	100	50 black, 20 color
Cards	110 lb. max (200 gsm)	40	40
Envelopes	20 to 24 lb. (75 to 90 gsm)	15	10
Banners	16-24 lb. (60-90 gsm)	20	20 or less
Transparency film	N/A	25	25 or less
Labels	N/A	20	20
4 x 6 inch (10 x 15 cm) Photo	145 lb. (236 gsm)	30	30

1 Maximum capacity

2 Output tray capacity is affected by the type of paper and the amount of ink you are using. HP recommends emptying the tray frequently.

paper sizes

Type	Size
Paper	Letter: 8.5 x 11 in. (216 x 279 mm) Legal: 8.5 x 14 in. (216 x 355.6 mm) Executive: 7.25 x 10.5 in. (184.2 x 266.7 mm) A4: 210 x 297 mm A5: 148 x 210 mm B5: 182 x 257 mm
Banner	Letter: 8.5 x 11 in. (216 x 279 mm) A4: 8.27 x 11.69 in. (210 x 297 mm)
Envelopes	U.S. #10: 4.12 x 9.5 in. (104.8 x 241.3 mm) A2: 4.37 x 5.75 in. (111 x 146 mm) DL: 4.33 x 8.66 in. (110 x 220 mm) C6: 4.49 x 6.38 in. (114 x 162 mm)
Transparency films	Letter: 8.5 x 11 in. (216 x 279 mm) A4: 210 x 297 mm
Cards	3 x 5 in. (76.2 x 127 mm) 4 x 6 in. (101.6 x 152 mm) 5 x 8 in. (127 x 203.2 mm) A6: 105 x 148.5 mm hagaki post card: 100 x 148 mm
Labels	Letter: 8.5 x 11 in. (216 x 279 mm) A4: 210 x 297 mm
Custom	3 x 5 in. up to 8.5 x 14 in. (76.2 x 127 up to 216 x 356 mm)

print specifications

- 1200 x 1200 dpi black with resolution enhancement technology (RET)
- 1200 x 1200 dpi color with HP PhotoREt III
- Method: Drop-on-demand thermal inkjet
- Language: HP PCL Level 3, PCL3 GUI or PCL 10
- Print speeds vary according to the complexity of the document.
- Duty cycle: 500 printed pages per month (average)
- Duty cycle: 3000 printed pages per month (maximum)

Mode		Resolution (dpi)	Speed (ppm)
Best/inkjet/1200	Black	1200 x 1200	2
	Color	1200 x 1200 (up to 4800 dpi optimized ¹)	.5
Normal	Black	600 x 600	7
	Color	600 x 600	4
Everyday	Black	600 x 600	8
	Color	600 x 600	6
Fast	Black	300 x 300	up to 17.0
	Color	300 x 300	up to 12.0

¹ Up to 4800 x 1200 optimized dpi color printing on premium photo papers and 1200 x 1200 input dpi when printing from a computer.

print margin specifications

	Top (leading edge)	Bottom (trailing edge) ¹	Left	Right
Sheet Paper				
U.S. letter	.07 in. (1.8 mm)	.46 in. (11.7 mm)	.25 in. (6.4 mm)	.25 in. (6.4 mm)
U.S. legal	.07 in. (1.8 mm)	.46 in. (11.7 mm)	.25 in. (6.4 mm)	.25 in. (6.4 mm)
U.S. executive	.07 in. (1.8 mm)	.46 in. (11.7 mm)	.25 in. (6.4 mm)	.25 in. (6.4 mm)
ISO A4	.07 in. (1.8 mm)	.46 in. (11.7 mm)	.13 in. (3.2 mm)	.13 in. (3.2 mm)
ISO A5	.07 in. (1.8 mm)	.46 in. (11.7 mm)	.13 in. (3.2 mm)	.13 in. (3.2 mm)
JIS B5	.07 in. (1.8 mm)	.46 in. (11.7 mm)	.13 in. (3.2 mm)	.13 in. (3.2 mm)
Envelopes				
U.S. No. 10	.13 in. (3.2 mm)	.46 in. (11.7 mm)	.13 in. (3.2 mm)	.13 in. (3.2 mm)
A2 (5.5 baronial)	.13 in. (3.2 mm)	.46 in. (11.7 mm)	.13 in. (3.2 mm)	.13 in. (3.2 mm)
Intl. DL	.13 in. (3.2 mm)	.46 in. (11.7 mm)	.13 in. (3.2 mm)	.13 in. (3.2 mm)
Intl. C6	.13 in. (3.2 mm)	.46 in. (11.7 mm)	.13 in. (3.2 mm)	.13 in. (3.2 mm)
Cards				
U.S. 3 x 5 in.	.07 in. (1.8 mm)	.46 in. (11.7 mm)	.13 in. (3.2 mm)	.13 in. (3.2 mm)
U.S. 4 x 6 in.	.07 in. (1.8 mm)	.46 in. (11.7 mm)	.13 in. (3.2 mm)	.13 in. (3.2 mm)
U.S. 5 x 8 in.	.07 in. (1.8 mm)	.46 in. (11.7 mm)	.13 in. (3.2 mm)	.13 in. (3.2 mm)

	Top (leading edge)	Bottom (trailing edge) ¹	Left	Right
ISO and JIS A6	.07 in. (1.8 mm)	.46 in. (11.7 mm)	.13 in. (3.2 mm)	.13 in. (3.2 mm)
hagaki (100 x 148 mm)	.07 in. (1.8 mm)	.46 in. (11.7 mm)	.13 in. (3.2 mm)	.13 in. (3.2 mm)
Borderless photo (4 x 6 in.)	0	.46 in. (11.7 mm)	0	0
Borderless A6 card (105 x 148.5 mm)	0	.46 in. (11.7 mm)	0	0
Borderless hagaki (100 x 148 mm)	0	.46 in. (11.7 mm)	0	0

¹ This margin is not LaserJet-compatible, however, the total writing area is compatible. The writing area is offset from center by .21 inches (5.4 mm), which causes asymmetric top and bottom margins.

copy specifications

- Digital image processing
- Up to 99 copies from original (varies by model)
- Digital zoom from 25 to 400% (varies by model)
- Fit to page, Poster, Many on page
- Up to 17 cpm black, 12 cpm color (varies by model)
- Copy speeds vary according to the complexity of the document

Mode	Color/Black	Speed (ppm)	Print Resolution (dpi)	Scan Resolution (dpi) ¹
Best	Black	up to 0.8	1200 x 1200 ²	1200 x 2400
	Color	up to 0.8	1200 x 1200 ²	1200 x 2400
Normal	Black	up to 7	600 x 1200	600 x 1200
	Color	up to 4	600 x 600	600 x 1200
Fast	Black	up to 17	300 x 1200	600 x 1200
	Color	up to 12	600 x 300	600 x 1200

¹ Maximum at 400% scaling

² On photo paper or premium inkjet paper

photo card specifications

The hp psc supports the following photo cards:

- Compact Flash (R) Type I and II (including IBM Microdrive)
- Smart Media (R)
- Sony Memory Stick (R)
- Secure Digital



scan specifications

- Create photo projects
- Image editor included
- Readiris OCR software automatically converts to editable text

- Scan speeds vary according to the complexity of the document

Item	Description
Resolution	1200 x 2400 dpi optical, up to 9600 dpi enhanced
Color	48-bit color 8-bit grayscale (256 levels of gray)
Interface	TWAIN-compliant
Scanning Area	US Letter, A4

physical specifications

- Height: 8.7 in. (22 cm)
- Width: 18.2 in. (46.3 cm)
- Depth: 15.7 in. (40 cm)
- Weight: 19.5lb. (8.85 kg)

power specifications

- Power consumption: 75W maximum
- Source (Input) Voltage: 100 to 240 VAC, grounded
- Input Frequency: 50/60 Hz
- Current: 1.0 A maximum

environmental specifications

- Recommended Operating Temperature Range: 15° to 32° C (59° to 90° F)
- Allowable Operating Temperature Range: 5° to 40° C (41° to 104° F)
- Humidity: 15% to 85% RH non-condensing
- Non-operating (Storage) Temperature Range: -40° to 60° C (-40° to 140° F)

additional specifications

- Memory: 8.0-MB ROM, 16.0-MB RAM

If you have Internet access, you can get acoustic information from the HP website at:

<http://www.hp.com/support>

environmental product stewardship program

protecting the environment

Hewlett-Packard is committed to providing quality products in an environmentally sound manner. This product has been designed with several attributes to minimize impacts on our environment.

For more information, visit HP's Commitment to the Environment website at:

<http://www.hp.com/hpinfo/community/environment/index.htm>

ozone production

This product generates no appreciable ozone gas (O₃).

energy consumption

Energy usage drops significantly while in Power Save mode, which saves natural resources, and saves money without affecting the high performance of this product. This product qualifies for ENERGY STAR®, which is a voluntary program established to encourage the development of energy-efficient office products.



ENERGY STAR is a U.S. registered service mark of the U.S. EPA. As an ENERGY STAR partner, HP has determined that this product meets ENERGY STAR guidelines for energy efficiency.

For more information on ENERGY STAR guidelines, visit the following web site:

<http://www.energystar.gov>

paper use

This product is suited for the use of recycled paper according to DIN 19309.

plastics

Plastic parts over 25 grams are marked according to international standards that enhance the ability to identify plastics for recycling purposes at the end of the product's life.

material safety data sheets

Material safety data sheets (MSDS) can be obtained from the HP web site at:

<http://www.hp.com/go/msds>

If you are in the United States or Canada and do not have access to the Internet, call the U.S. HP FIRST fax-on-demand service at (800) 231-9300. Use Index number 7 for a listing of the material safety data sheets.

International customers without Internet access should call (404) 329-2009 for further information.

recycling program

HP offers an increasing number of product return and recycling programs in many countries/regions, as well as partnering with some of the largest electronic recycling centers throughout the world. HP also conserves resources by refurbishing and reselling some of its most popular products.

regulatory notices

The following sections are statements from various regulatory agencies.

FCC statement

The United States Federal Communications Commission (in 47 CFR 15.105) has specified that the following notice be brought to the attention of users of this product.

Declaration of Conformity: This equipment has been tested and found to comply with the limits for a Class B digital device, pursuant to part 15 of the FCC Rules. Operation is subject to the following two conditions: (1) this device may not cause harmful interference, and (2) this device must accept any interference received, including interference that may cause undesired operation. Class B limits are designed to provide reasonable protection against harmful interference in a residential installation. This equipment generates, uses, and can radiate radio frequency energy, and, if not installed and used in accordance with the instructions, may cause harmful interference to radio communications. However, there

is not guarantee that interference will not occur in a particular installation. If this equipment does cause harmful interference to radio or television reception, which can be determined by turning the equipment off and on, the user is encouraged to try to correct the interference by one or more of the following measures:

- Reorient the receiving antenna.
- Increase the separation between the equipment and the receiver.
- Connect the equipment into an outlet on a circuit different from that to which the receiver is connected.
- Consult the dealer or an experienced radio/TV technician for help.

Product Regulations Manager, Hewlett-Packard Company, San Diego, (858) 655-4100.

The user may find the following booklet prepared by the Federal Communications Commission helpful: *How to Identify and Resolve Radio-TV Interference Problems*. This booklet is available from the U.S. Government Printing Office, Washington DC, 20402. Stock No. 004-000-00345-4.

Caution! Pursuant to Part 15.21 of the FCC Rules, any changes or modifications to this equipment not expressly approved by the Hewlett-Packard Company, may cause harmful interference and void the FCC authorization to operate this equipment.

doc statement / déclaration de conformité (Canada)

Le présent appareil numérique n'émet pas de bruit radioélectrique dépassant les limites applicables aux appareils numériques de la classe B prescrites dans le Règlement sur le brouillage radioélectrique édicté par le ministère des Communications du Canada.

This digital apparatus does not exceed the Class B limits for radio noise emissions from digital apparatus set out in the Radio Interference Regulations of the Canadian Department of Communications.

notice to users of the Canadian telephone network

The Industry Canada label identifies certified equipment. This certification means that the equipment meets certain telecommunications network protective, operational and safety requirements as prescribed in the appropriate Terminal Equipment Technical Requirements document(s). The Department does not guarantee the equipment will operate to the user's satisfaction.

Before installing this equipment, users should ensure that it is permissible to be connected to the facilities of the local telecommunications company. The equipment must also be installed using an acceptable method of connection. The customer should be aware that compliance with the above conditions may not prevent degradation of service in some situations.

Repairs to certified equipment should be coordinated by a representative designated by the supplier. Any repairs or alterations made by the user to this equipment, or equipment malfunctions, may give the telecommunications company cause to request the user to disconnect the equipment.

Users should ensure for their own protection that the electrical ground connections of the power utility, telephone lines and internal metallic water pipe system, if present, are connected together. This precaution may be particularly important in rural areas.

Caution! Users should not attempt to make such connections themselves, but should contact the appropriate electric inspection authority, or electrician, as appropriate.

Note: The Ringer Equivalence Number (REN) assigned to each terminal device provides an indication of the maximum number of terminals allowed to be connected to a telephone interface. The termination on an interface may consist of any combination of devices subject only to the requirement that the sum of the Ringer Equivalence Numbers of all the devices does not exceed 5.

The REN for this product is 0.3B, based on FCC Part 68 test results.

notice to all users of the European Economic Area (EEA)

This product is designed to interwork with the analogue telephone networks in the following countries/regions:

German	UK	Netherlands
France	Spain	Italy
Belgium	Luxembourg	Sweden
Austria	Denmark	Ireland
Norway	Finland	Switzerland
Greece	Portugal	

Network compatibility depends on customer selected settings, which must be reset to use the equipment on a telephone network in a country/region other than where the product was purchased. Contact the vendor or Hewlett-Packard Company if addition product support is necessary.

This equipment has been certified by the manufacturer in accordance with Directive 1999/5/EC (annex II) for Pan-European single-terminal connection to the public switched telephone network (PSTN). However, due to differences between the individual PSTNs provided in different countries/regions, the approval does not, of itself, give an unconditional assurance of successful operation on every PSTN network termination point. In the event of problems, you should contact your equipment supplier in the first instance.

notice to users of the Irish telephone network

This equipment is designed for DTMF tone dialing and loop disconnect dialing. In the unlikely event of problems with loop disconnect dialing, it is recommended to use this equipment only with the DTMF tone dial setting.

notice to users of the German telephone network

The HP 2170 Series products are designed to connect only to the analogue public-switched telephone network (PSTN). Please connect the TAE N telephone connector plug, provided with the hp psc 2170 series, into the wall socket (TAE 6) code N. The hp psc 2170 series products can be used as a single device and/or in combination (in serial connection) with other approved terminal equipment.

geräuschemission

LpA < 70 dB
am Arbeitsplatz
im Normalbetrieb
nach DIN 45635 T. 19

VCCI-2 (Japan)

この装置は、情報処理装置等電波障害自主規制協議会（VCCI）の基準に基づくクラスB情報技術装置です。この装置は、家庭環境で使用することを目的としていますが、この装置がラジオやテレビジョン受信機に近接して使用されると受信障害を引き起こすことがあります。

取り扱い説明書に従って正しい取り扱いをして下さい。

notice to Korean customers**사용자 안내문 (B급 기기)**

이 기기는 비업무용으로 전자파장애검정을 받은 기기로서, 주거지역에서는 물론 모든 지역에서 사용할 수 있습니다.

This section explains the support services information provided by Hewlett-Packard.

If you are unable to find the answer you need in the printed or onscreen documentation supplied with your product, you can contact one of the HP support services listed in the following pages. Some support services are available only in the U.S. and Canada, while others are available in many countries/regions worldwide. If a support service number is not listed for your country/region, contact your nearest authorized HP dealer for help.

get support and other information from the internet

If you have Internet access, you can get help from the following HP Web site:

<http://www.hp.com/support>

The Web site offers technical support, drivers, supplies, and ordering information.

hp customer support

Software programs from other companies may be included with your HP PSC. If you experience problems with any of those programs, you will receive the best technical assistance by calling the experts at that company.

If you need to contact HP Customer Support, do the following before you call.

- 1 Make sure that:
 - a. Your unit is plugged in and turned on.
 - b. The specified print cartridges are installed correctly.
 - c. The recommended paper is properly loaded in the input tray.
- 2 Reset your unit:
 - a. Turn off the unit using the **On** button located on the unit's front panel.
 - b. Unplug the power cord from the back of the unit.
 - c. Plug the power cord back into the unit.
 - d. Turn on the unit using the **On** button.
- 3 For more information, check the HP website at:
<http://www.hp.com/support>
- 4 If you are still experiencing problems and need to speak with an HP Customer Support Representative:
 - Have your serial number and service ID ready. To display your serial number, on the front panel, press **Enter** and **Start Copy, Black** at the same time, until the serial number appears in the front-panel display. To display your service ID, on the front panel, press **Enter** and **Start Copy, Color** at the same time, until **SERV ID:** and the number appear in the front-panel display
 - Print a Self-Test Report. See **print a self-test report** on page 38 for information on printing this report.
 - Make a color copy.
 - Be prepared to describe your problem in detail.
- 5 Call HP Customer Support. Be near your unit when you call.

call in the U.S. during warranty

Call (208) 323-2551. This service is free during the warranty period; however, your standard long-distance phone charges still apply. A fee may apply outside the warranty period.

U.S. phone support is available in both English and Spanish languages 24 hours a day, 7 days a week (days and hours of support may change without notice).

call elsewhere in the world

The numbers listed below are current as of the printing date of this guide. For a list of current international HP Support Service numbers, visit this address and choose your own country/region or language:

<http://www.hp.com/support>

For Korea, you can also visit this address:

<http://www.hp.co.kr/>

You can call the HP support center in the following countries/regions. If your country/region is not listed, contact your local dealer or nearest HP Sales and Support Office to find out how to obtain services.

Support service is free during the warranty period; however, your standard long-distance phone charges will apply. In some cases, a flat fee per single incident will also apply.

For phone support in Europe, please check for the details and conditions of phone support in your country/region by consulting the following Web site:

<http://www.hp.com/support>

Alternatively, you can ask your dealer or call HP at the phone number indicated in this booklet.

As part of our constant efforts to improve our phone support service, we advise you to check our website on a regular basis for new information regarding service features and delivery.

country/region	hp technical support	country/region	hp technical support
Algeria ¹	+212 22404 747	Malaysia	1-800-805405
Argentina	0810-555-5520	Mexico	01-800-472-6684
Australia	+61 3 8877 8000 1902 910 910	Mexico (Mexico City)	5258-9922
Austria	+43 (0) 810 00 6080	Morocco ¹	+212 22404 747
Bahrain (Dubai)	+971 4 883 8454	Netherlands	+31 (0) 20 606 8751
Belgium (Dutch)	+32 (0) 2 626 8806	New Zealand	+64 (9) 356 6640
Belgium (French)	+32 (0) 2 626 8807	Norway	+47 22 11 6299
Brazil (Grande Sao Paulo)	(11) 3747 7799	Oman	+971 4 883 8454
Brazil (Demais Localidades)	0800 157751	Palestine	+971 4 883 8454
Canada during warranty	(905) 206 4663	Panama	001-800-7112884
Canada post-warranty (per-call charge)	1-877-621-4722	Peru	0-800-10111
Caribbean & Central America	1-800-711-2884	Philippines	632-867-3551
Chile	800-10111	Poland	+48 22 865 98 00
China	86 10 6868 7980	Portugal	+351 21 3176333
Colombia	9-800-114-726	Puerto Rico	1-877-232-0589
Costa Rica	0-800-011-0524	Qatar	+971 4 883 8454
Czech Republic	+42 (0) 2 6130 7310	Romania	+40 1 315 44 42 01 3154442

country/region	hp technical support	country/region	hp technical support
Denmark	+45 39 29 4099	Russia, Moscow	+7 095 797 3520
Ecuador	1-800-225528	Russia, St. Petersburg	+7 812 346 7997
Europe (English)	+44 (0) 207 512 5202	Saudi Arabia	+800 897 14440
Egypt	02 532 5222	Singapore	(65) 6272-5300
Finland	+358 (0) 203 47 288	Slovakia	+421 2 682 08080
France (0.34 Euro/min.)	+0836696022	South Africa (RSA)	086 000 1030
Germany (0.12 Euro/min.)	+49 (0) 180 52 58 143	South Africa, Outside Republic	+27-11 258 9301
Greece	+30 1060 73 603	Spain	+34 902 321 123
Hong Kong (SAR)	+85 (2) 3002 8555	Sweden	+46 (0)8 619 2170
Guatemala	1800-999-5305	Switzerland ²	+41 (0) 84 880 1111
Hungary	+36 (0) 1 382 1111	Taiwan	+886-2-2717-0055 0800 010 055
India	1-600-112267 91 11 682 6035	Thailand	+66 (2) 661 4000
Indonesia	62-21-350-3408	Tunisia ¹	+216 1891 222
Ireland	+353 (0) 1 662 5525	Turkey	+90 216 579 7171
Israel	+972 (0) 9 9524848	Ukraine	+7 (380-44) 490-3520
Italy	+39 0226410350	United Arab Emirates	+971 4 883 8454
Japan	0570 000 511 +81 3 3335 9800	United Kingdom	+44 (0) 207 512 52 02
Jordan	+971 4 883 8454	Venezuela	0800-47468368 or 800-477-7777
Korea (Seoul) Korea (outside Seoul)	+82 (2) 3270 0700 080 999 0700	Venezuela (Caracas)	(502) 207-8488
Kuwait	+971 4 883 8454	Vietnam	84 (0) 8-823-4530
Lebanon	+971 4 883 8454	Yemen	+971 4 883 8454

1 This Call Center supports French speaking customers from the following countries/regions: Morocco, Tunisia, and Algeria.

2 This Call Center supports German, French and Italian speaking customers in Switzerland.

call in Australia post-warranty

If your product is not under warranty, you can call 03 8877 8000. A per-incident, out-of-warranty support fee of \$27.50 (inc GST) will be charged to your credit card. You can also call 1902 910 910 (\$27.50 charged to your phone account) from 9:00 A.M. to 5:00 P.M. Monday through Friday. (Charges and support hours are subject to change without notice.)

prepare your unit for shipment

If after contacting HP Customer Support or returning to the point of purchase, you are requested to send your unit in for service, please follow the power off and rebox steps below to avoid further damage to the HP product.

- 1 Turn on the unit.
Disregard steps 1 through 6, if your unit will not turn on and the print carriage is in the home position. You will not be able to remove the print cartridges. Proceed to step 7.
- 2 Open the print cartridge access door.
- 3 Remove the print cartridges from their holders, and lower the latches. See **replace the print cartridges** on page 39 for information on removing the print cartridges. Place cartridges in an airtight bag.
Caution! Remove both print cartridges and lower both latches. Failure to do so may damage your unit.
- 4 Turn off the unit.
- 5 Close the print cartridge access door.
- 6 Pack the unit for shipment using adequate packing materials.

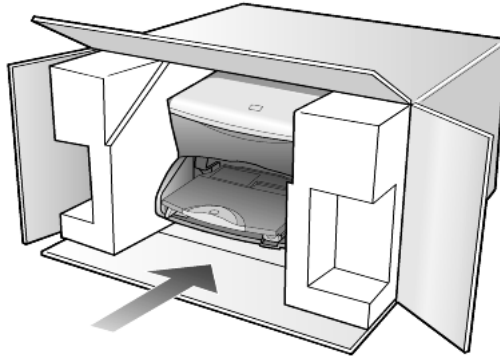

Shipping damage caused by improper packaging and/or improper transportation is not covered under the warranty.

- 7 Place the return shipping label on the outside of the box.
- 8 Include the following items in the box:
 - A brief description of symptoms for service personnel (samples of print quality problems are helpful).
 - A copy of the sales slip or other proof of purchase to establish the warranty coverage period.
 - Your name, address, and a phone number where you can be reached during the day.

hp distribution center

To order HP PSC software, a copy of the printed Reference Guide, a setup poster, or other customer-replaceable parts, do one of the following:

- In the U.S. or Canada, call (208) 323 2551.
- Visit this website:

www.hp.com/cposupport/software.html

hp psc 2170 series

Duration of Limited Warranty (hardware and labor): 1 Year

Duration of Limited Warranty (CD media): 90 Days

Duration of Limited Warranty (print cartridges): Until the HP ink is depleted or the "end of warranty" date printed on the cartridge has been reached, whichever occurs first.

warranty service

express service

To obtain HP express repair service, the customer must contact an HP service office or an HP Customer Support Center for basic troubleshooting first. See **hp customer support** on page 61 for steps to take before calling Customer Support.

If a customer unit needs a minor part replacement and these parts can normally be replaced by the customer, the customer-replaceable components may be serviced through expedited part shipment. In this event, HP will prepay shipping charges, duty and taxes; provide telephone assistance on replacement of the component; and pay shipping charges, duty, and taxes for any part that HP asks to be returned.

The HP Customer Support Center may direct customers to designated authorized service providers who are certified by HP to service the HP product.

warranty upgrades

Upgrade your standard factory warranty to a total of three years with the HP SUPPORTPACK. Service coverage begins on product purchase date and the pack must be purchased within the first 180 days of product purchase. This program offers phone support from 6:00 A.M. to 10:00 P.M. Mountain Standard Time (MST) Monday through Friday and 9:00 A.M. to 4:00 P.M. (MST) on Saturdays. If during your technical support call it is determined that you need a replacement product, then HP will ship you this product next business day free of charge. Available in U.S. only.

For more information, please call 1-888-999-4747 or visit the following HP Web site:

<http://www.hp.com/go/hpsupportpack>

Outside the U.S., please call your local HP Customer Support office. See **call elsewhere in the world** on page 62 for a list of international Customer Support numbers.

returning your hp psc 2170 series for service

Before returning your HP PSC for service, you must call HP Customer Support. See **hp customer support** on page 61 for steps to take before calling Customer Support.

hewlett-packard limited global warranty statement

extent of limited warranty

Hewlett-Packard ("HP") warrants to the end-user customer ("Customer") that each HP PSC 2170 Series product ("Product"), including related software, accessories, media, and supplies, shall be free from defects in material and workmanship for the duration, which begins on the date of purchase by the Customer.

For each software Product, HP's limited warranty applies only to a failure to execute programming instructions. HP does not warrant that the operation of any Product shall be uninterrupted or error free.

HP's limited warranty covers only those defects which arise as a result of normal use of a Product, and does not cover any other problems, including those which arise as a result of (a) improper maintenance or modification, (b) software, accessories, media, or supplies not provided or supported by HP, or (c) operation outside the Product's specifications.

For any hardware Product, the use of a non-HP print cartridge or a refilled print cartridge does not affect either the warranty to the Customer or any HP support contract with the Customer. However, if Product failure or damage is attributable to the use of a non-HP or refilled print cartridge, HP shall charge its standard labor and materials charges to service the Product for the failure or damage.

If HP receives, during the applicable warranty period, notice of a defect in any Product, HP shall either repair or replace the defective Product, at HP's option. Where labor charges are not covered by HP's limited warranty, repairs shall be at HP's standard charges for labor.

If HP is unable to repair or replace, as applicable, a defective Product which is covered by HP's warranty, HP shall, within a reasonable time after being notified of the defect, refund the purchase price for the Product.

HP shall have no obligation to repair, replace, or refund until the Customer returns the defective Product to HP.

Any replacement product may be either new or like-new, provided that it has functionality at least equal to that of the Product being replaced.

HP products, including each Product, may contain remanufactured parts, components, or materials equivalent to new in performance.

HP's limited warranty for each Product is valid in any country/region or locality where HP has a support presence for the Product and where HP has marketed the Product. The level of warranty service may vary according to local standards. HP shall have no obligation to alter the form, fit, or function of the Product in order to make it operate in a country/region or locality for which the Product was never intended to operate.

limitations of warranty

TO THE EXTENT ALLOWED BY LOCAL LAW, NEITHER HP NOR ITS THIRD PARTY SUPPLIERS MAKE ANY OTHER WARRANTY OR CONDITION OF ANY KIND, WHETHER EXPRESS OR IMPLIED, WITH RESPECT TO THE COVERED HP PRODUCTS, AND SPECIFICALLY DISCLAIM THE IMPLIED WARRANTIES OR CONDITIONS OF MERCHANTABILITY, SATISFACTORY QUALITY, AND FITNESS FOR A PARTICULAR PURPOSE.

limitations of liability

To the extent allowed by local law, the remedies provided in this Limited Warranty Statement are the Customer's sole and exclusive remedies.

TO THE EXTENT ALLOWED BY LOCAL LAW, EXCEPT FOR THE OBLIGATIONS SPECIFICALLY SET FORTH IN THIS LIMITED WARRANTY STATEMENT, IN NO EVENT SHALL HP OR ITS THIRD PARTY SUPPLIERS BE LIABLE FOR DIRECT, INDIRECT, SPECIAL, INCIDENTAL, OR CONSEQUENTIAL DAMAGES, WHETHER BASED ON CONTRACT, TORT, OR ANY OTHER LEGAL THEORY AND WHETHER ADVISED OF THE POSSIBILITY OF SUCH DAMAGES.

local law

This Limited Warranty Statement gives the Customer specific legal rights. The Customer may also have other rights which vary from state to state in the United States, from province to province in Canada, and from country/region to country/region elsewhere in the world.

To the extent this Limited Warranty Statement is inconsistent with local law, this Statement shall be deemed modified to be consistent with such local law. Under such local law, certain disclaimers and limitations of this Statement may not apply to the Customer. For example, some states in the United States, as well as some governments outside the United States (including provinces in Canada), may:

Preclude the disclaimers and limitations in this Statement from limiting the statutory rights of a consumer (e.g. the United Kingdom);

Otherwise restrict the ability of a manufacturer to enforce such disclaimers or limitations; or

Grant the Customer additional warranty rights, specify the duration of implied warranties which the manufacturer cannot disclaim, or not allow limitations on the duration of implied warranties.

FOR CONSUMER TRANSACTIONS IN AUSTRALIA AND NEW ZEALAND, THE TERMS IN THIS LIMITED WARRANTY STATEMENT, EXCEPT TO THE EXTENT LAWFULLY PERMITTED, DO NOT EXCLUDE, RESTRICT, OR MODIFY, AND ARE IN ADDITION TO, THE MANDATORY STATUTORY RIGHTS APPLICABLE TO THE SALE OF THE COVERED HP PRODUCTS TO SUCH CUSTOMERS.

Numerics

4-by-6 inch photo paper
load 12

A

additional specifications 55
adjust settings
 view angle 47
align print cartridges 41

B

banner paper
 tips on loading 14
best copy quality 26
buttons
 front panel 3
 setup 6
 Start Black 33
 Start Color 33

C

cancel
 copy 31
 scan 34
cartridges
 align 41
 replace 39
clean
 print cartridges 42
 the exterior 37
 the glass 37
 the lid backing 37
color
 intensity of copy 27
CompactFlash 17
contact Customer Support 61
continuous paper
 tips on loading 14
contrast
 front-panel display 47
copy
 button 3
 change default settings 27
 color intensity 27
 darken 27
 defaults 27
 enhance photo colors 27

enhancements 27
enlarge 26
fit to page 28
lighten 27
make a poster 30
make copies 25
photo 28
quality 26
reduce 26
resize 5, 26
set number of copies 5, 26
several copies on a page 29
special copy jobs 28
specifications 54
speed 26
stop 31
T-shirt transfer 30
Customer Support 61
 call from U.S. 61
 call outside U.S. 62

D

darken a copy 27
default settings
 change for copy 27
 restore factory defaults 42

E

enhancements 27
enlarge a copy 26, 28
envelopes
 load 11
environmental product
 stewardship program 55
environmental specifications 55

F

factory defaults
 change for copying 27
 restore 42
fast copy quality 26
fit to page 28
front panel
 display 3
 features 3
 scan from 33
 scroll speed of display 43

tutorial 3
front-panel display
 set view angle 47

G

glass cleaning 37
greeting cards
 load 13

H

help 1
 HP Web site 61
HP customer support 61
HP Director
 review 6
HP distribution center 64
HP papers
 tips on loading 13
HP Photo & Imaging
 Gallery 19, 34
HP PSC
 software 6

I

ink cartridges, see print
 cartridges
inkjet paper
 load 13
insert
 photo card 18
intensity of color copy 27
introduction
 to the HP Director 6
iron-on T-shirt transfers 30

L

labels
 load 13
lamp power save mode 42
lid backing
 clean 37
light power save mode 42
lighten or darken copies 27
load
 change the paper type 14
 envelopes 11
 original on the glass 9

- paper **9**
- photo paper **12**
- postcards **12, 13**
- print cartridges **39**
- set the paper size **14**
- tips **13**

M

- maintenance
 - align print cartridges **41**
 - clean print cartridges **42**
 - clean the exterior **37**
 - clean the glass **37**
 - clean the lid backing **37**
 - power save mode time **42**
 - replace print cartridges **39**
 - restore factory defaults **42**
 - self-test report **38**
- memory card, see photo card
- Memory Stick **17**
- menus
 - copy setup **31**
 - maintenance **43**
 - print reports **43**
- multiple copies on a page **29**

N

- normal copy quality **26**
- number of copies
 - set **5, 26**

O

- options menu
 - photo card commands **23**
- order print cartridges **74**
- originals
 - how to place on glass **9**
- output tray **14**
 - extender **11**

P

- paper
 - change the type **14**
 - load **9**
 - paper size specifications **52**
 - set the size **14**
 - specifications **52**
 - tips on loading **13**
- paper-tray
 - capacities **52**
 - load **9**
- phone numbers
 - support services **61**
- photo card

- CompactFlash **17**
- HP Photo & Imaging Gallery **19**
- insert a card **18**
- inserted incorrectly **18**
- Memory Stick **17**
- options menu **23**
- print a DPOF file **22**
- print a proof sheet **19**
- print individual photos **21**
- save files to computer **18**
- scan a proof sheet **20**
- SecureDigital **17**
- SmartMedia **17**
- specifications **54**
 - what is a photo card **17**
- photo mode enhancement **28**
- photo paper
 - load **12**
- photos
 - enhance copy **28**
 - enhance copy color **27**
 - print a DPOF file **22**
 - print directly from photo card **21**
 - print individual photos **21**
 - select on proof sheet **19**
- physical specifications **55**
- postcards
 - load **12, 13**
- poster
 - copy to **30**
- power save mode setup **42**
- power save mode time **42**
- power specifications **55**
- print
 - DPOF file **22**
 - envelopes **11**
 - individual photos **21**
 - margin specifications **53**
 - photos directly from photo card **21**
 - proof sheet **19**
 - self-test report **38**
 - specifications **53**
 - to banner paper **14**
- print cartridges
 - align **41**
 - clean **42**
 - handling **38**
 - protector **38**
 - replace **39**
 - store **38**
- prompt delay
 - set **43**

- proof sheet
 - print **19**
 - scan **20**
 - select photos **19**
- protector
 - print cartridge **38**

Q

- quality
 - copy **26**
- quick start **3**
 - review the HP Director **6**
 - use with a computer **6**

R

- reduce a copy **26, 28**
- regulatory notices **56**
- reinstall software **48**
- remove software **48**
- reports
 - self-test **38**
- resize a copy **5, 26, 28**
- restore factory settings **42**
- returning your HP PSC 2170 Series for service **65**

S

- save
 - a scanned image **33**
 - photos to computer **18**
- scan
 - button **3**
 - different destination **34**
 - from front panel **33**
 - proof sheet **20**
 - specifications **54**
 - stop **34**
 - to HP Photo & Imaging Gallery **34**
- scroll speed
 - front panel display **43**
- SecureDigital **17**
- self-test report **38**
- set
 - number of copies **26**
 - power save mode **42**
 - prompt delay **43**
 - scroll speed **43**
 - view angle **47**
- settings
 - best copy quality **26**
 - copy **27**
 - copy a photo **28**
 - copy color intensity **27**

- copy defaults **27**
- copy quality **26**
- copy speed **26**
- darken a copy **27**
- enlarge a copy **26**
- fast copy quality **26**
- lighten a copy **27**
- normal copy quality **26**
- power save mode **42**
- prompt delay **43**
- reduce a copy **26**
- scroll speed **43**
- text enhancement **27**
- setup
 - additional information **45**
 - button **6**
- SmartMedia **17**
- software
 - introduction **6**
 - remove and reinstall **48**
- specifications
 - additional **55**
 - copy **54**

- environmental **55**
- paper **52**
- paper sizes **52**
- paper-tray capacities **52**
- photo card **54**
- physical **55**
- power **55**
- print **53**
- print margins **53**
- scan **54**
- stop
 - copy **31**
 - scan **34**
- support **61**
- support services **61**
- system requirements **51**

T

- telephone numbers **61**
- text
 - enhance copy **27**
- transparency film

- tips on loading **13**
- troubleshooting, remove and
 - reinstall software **48**
- T-shirt transfer **30**
 - load **13**
- tutorial **3**
 - before you begin **3**
 - front panel features **3**

U

- USB cable installation **48**

V

- view angle, set **47**

W

- warranty **61**
 - service **65**
 - statement **65**
 - upgrades **65**

declaration of conformity

According to ISO/IEC Guide 22 and EN 45014

Manufacturer's Name and Address:

Hewlett-Packard Company, 16399 West Bernardo Drive, San Diego, CA 92127-1899, USA

declares that the
product

Product Name: hp psc 2170 series (Q3066A)

Model Number(s): psc 2170 (Q3067A), psc 2175 (Q3068A), psc 2175xi (Q3069A), psc 2175v (Q3070A), psc 2171 (Q3072A), psc 2179 (Q3071A)

Product Options: All

conforms to the following Product Specifications:

Safety: EN60950:1992 +A1, A2, A3, A4 & A11
IEC60950:1991 +A1, A2, A3 & A4
UL1950/CSA 22.2 No. 950, 3rd Edn: 1995
NOM-019-SCFI-1993

EMC: CISPR22:1993 +A1 & A2 / EN55022:1994, +A1 & A2 -Class B
CISPR24:1997/EN55024:1998
IEC 61000-3-2:1995 / EN61000-3-2:1995
IEC 61000-3-3:1994 / EN61000-3-3:1995
AS/NZS 3548: 1992
CNS13438
FCC Part 15-Class B / ICES-003, Issue 2 / VCCI-2
GB 9254-1998

Supplementary Information

The Product herewith complies with the requirements of the Low Voltage Directive 73/23/EEC, the EMC Directive 89/336/EEC and carries the CE marking accordingly.

European Contact for regulatory topics only: Your local Hewlett-Packard Sales and Service Office
or
Hewlett-Packard GmbH.

Department HQ-TRE, Herrenberger Strasse 140, D-71034 Böblingen, Germany (FAX + 49-7031-14-3143)

order media

To order media such as HP Premium Inkjet Paper, HP Premium Inkjet Transparency Film, HP Iron-On T-shirt Transfer paper, or HP Greeting Cards, go to

www.hpshopping.com

For orders in countries other than the U.S. and Canada, select **other countries**, then click **Yes** to leave hpshopping.com. From this website, you can access hpshopping.com for your specific language or region.

order print cartridges

print cartridges	hp reorder number
HP black print cartridge	#56, 19 ml black print cartridge
HP black print cartridge	#27, 10 ml black print cartridge
HP color print cartridge	#57, 17 ml color print cartridge
HP photo color print cartridge	#58, 17 ml color print cartridge
HP tricolor print cartridge	#28, 8 ml color print cartridge

If you have Internet access, you can get more information from the HP website at:

www.hp.com/support

Visit the hp psc information center

It has everything you need to get the most value from your HP PSC.

- Technical Support
- Supplies and Ordering Information
- Project Tips
- Ways to Enhance Your Product

www.hp.com/support

© 2003 Hewlett-Packard Company

Printed in the U.S.A., Mexico, Germany, or Korea.



Q3066-90152